



London Underground  
**Station Design Idiom**





2

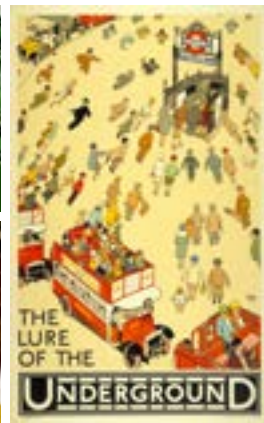



## Preface

**London Underground has an incredible history of being at the cutting edge of great design. We take real pride in having fantastic spaces for our passengers to move through, as well as being good places for our people to work.**

A station needs to be functional but attention to detail is critical to make people feel like they are using a system that cares for them, be that with stations so clean that they shine or that they have a fresh lick of paint or properly concealed cables. Good design can make all of these things possible.

I am proud of this Station Design Idiom, and I commend it to you all as we seek to create the next generation of iconic stations on this world class network.

**Mike Brown**

Commissioner for Transport for London



# Foreword

**Throughout the years, great design has literally put London's transport system on the map.**

It is one of the things that sets our system apart and is a defining part of what makes London such a great world city. It is however more than the iconic roundel or a map design that set the world standard. In fact, it is a statement of the care and attention we put into making every customer journey matter. It is about great places for our people to work in, environments that delight our customers, and a statement of quality and thought which epitomises how we put customers at the heart of everything we do.

We are custodians of the Underground at a great time in its history. We are modernising all aspects of our service so we can carry more people, more reliably and with higher standards of customer care than ever before. We are investing huge sums of money to do that every year. As this great city continues to evolve, the places and town centres, of which our stations and services are part, evolve as well. New commercial developments continue to change the face of London and of our stations too.

Our customer expectations change and we change to reflect what they need of us. As we respond to this dynamic content, we must ensure that we adapt in the right way.

We are rightfully proud of the legacy of the great pioneers of the past, in part because of how they brought clear thinking and quality to what they did; whether that's Harry Beck's Tube map, Holden's stations or Edward Johnson's typeface. If we were to look back in 50 years, would our successors be as proud of what we did, during this great time of investment and modernisation? Will the things we do today inspire those who work tirelessly to deliver excellent customer service? Will our customers, and our city, love us for what we did for them and how we contributed to London's rich fabric?

The London Underground Station Design Idiom has one simple aim: to bring good design to the forefront of our thinking. Good design should be the driver of decision-making, should permeate every level of the organisation, and should, ultimately, be celebrated by everyone. It doesn't have to cost more; it's an approach and an attitude of mind that thinks both broadly and carefully about what we do.



The Idiom has been put together to recognise, conserve and sympathetically nurture the design heritage that already exists and to inspire great design in all new projects, regardless of scale. This underpins our public service and our brand. At its core is a belief that good design and its implementation require a holistic approach and cannot be achieved in a piecemeal fashion. It can only be successful when there is excellent guidance and strong communication between everyone involved.

The scope of the Idiom is wide-ranging, from small interventions like repainting, to full station refurbishments, modernisations, and new builds. It complements existing Underground standards and guidance and is the first port of call for all station design decision-making on the network.

If we embrace the Idiom's principles, our customers and staff will thank us for it both today and in years to come.

**Gareth Powell**

Director of Strategy, London Underground  
and Chief Operating Officer, London Rail





# Contents

## A manifesto for good design

i	Design Idiom principles	9
ii	Design matters	11
iii	Hierarchy of customer needs	12
iv	Capacity	13
v	The Underground's design legacy	15
vi	Design Idiom opportunities	17
vii	The Design Idiom vision	19
viii	The ideal station	21
ix	At a glance: station exteriors	22
x	At a glance: ticket halls	23
xi	At a glance: routeways	24
xii	At a glance: escalators	25
xiii	At a glance: platforms	26
xiv	At a glance: external platforms	27
xv	At a glance: summary	28
xvi	How to use the Idiom	29

## 1.0 Achieve balance across the network

1.1	The need for balance	34
1.2	It starts with the roundel	36
1.3	The whole brand	37
1.4	Applying the principle of the circle and rectangle	38
1.5	Balancing network and local	39
1.6	Visual balance	42
1.7	Balance customer information with commercial opportunity	43
1.8	Balancing heritage and the future	44
1.9	Balance operational with ambience requirements	45
1.10	Balancing engineering with aesthetic style	46
1.11	Creating balance through hierarchy	47
1.12	Case study: the application of balance - Camden Town station	48

## 2.0 Look beyond the Bostwick gates

2.1	Stations designed for their place	53
2.2	Stations designed for people	55
2.3	Integrating stations into the local area	56
2.4	Linking stations to the public realm	57
2.5	Linking stations with local history	59
2.6	Station communities and retail	60
2.7	Station façades and frontages	61
2.8	Station portals and subway entrances	62
2.9	New stations	63
2.10	Interchanges with other modes of transport	64
2.11	Case study: knitting a station into its place - Southgate station	65

## 3.0 Consider wholeness

3.1	Considering the whole station	70
3.2	Looking at the big picture	70
3.3	Involving the team	71
3.4	Creating wholeness of space and form	72
3.5	Accessibility	73
3.6	Clutter-free legible spaces	75
3.7	Clutter examples and solutions	79
3.8	Commerce as part of the whole	81

## 4.0 Prioritise comfort for staff and customers

4.1	Building a network around people	88
4.2	Ownership of station spaces	89
4.3	Designing ticket halls from a staff perspective	90
4.4	Staff accommodation and back of house	91
4.5	Technology know-how	92
4.6	New uniform	94

## 5.0 Delight and surprise

5.1	Recognising what's special	99
5.2	Celebrating heritage	100
5.3	Promoting a sense of nature	101
5.4	Creating multi-sensory experiences	102
5.5	Design special lighting	103
5.6	Engaging with culture and Art on the Underground	104
5.7	Creating impact with advertising	105

## 6.0 Use materials to create atmosphere

6.1	London Underground's DNA	110
6.2	Network station design type map	112
6.3	Using the right flashcard	113
6.4	The 2015 palette	114
6.5	Applying the materials	117
6.6	The 2015 palette applied	118
6.7	Station exteriors	122
6.8	Getting the detail right	124
6.9	Modular systems	126
6.10	Materials formats and setting out	127
6.11	Floors and skirtings	128
6.12	Ceilings	129
6.13	Walls, columns, stairs and handrails	130
6.14	New works in existing stations	132
6.15	Craft	133
6.16	Case study: applying materials to an existing station - St. James's Park	134

## 7.0 Create ambience with lighting

7.1	The importance of good lighting	139
7.2	Applying the lighting principles	140
7.3	Layers of light	141
7.4	Understanding visual perception	143
7.5	Lighting at a glance	145
7.6	Lighting station exteriors	146
7.7	Lighting ticket halls	148
7.8	Lighting routeways	149
7.9	Lighting escalators and stairs	150
7.10	Lighting platforms	151
7.11	Natural illumination in stations	152
7.12	Adjusting from light to bright	154
7.13	Lighting surface level stations	155
7.14	Luminaire aesthetics	156
7.15	Lighting controls	157
7.16	Illuminance criteria and signage	158
7.17	Lighting technologies	160
7.18	The Night Tube	161
7.19	Performance criteria	162

## 8.0 Integrate products and services

8.1	Key products and services in a typical station	167
8.2	Placing products and services	169
8.3	Customer information hierarchy	170
8.4	Station entrances	172
8.5	Ticket halls	174
8.6	Escalators, stairs and lifts	176
8.7	Routeways	177
8.8	Platforms	178
8.9	Case study: creating clarity in a ticket hall - King's Cross western ticket hall	181

## 9.0 Prepare for the future

9.1	Designing for the whole life	186
9.2	Life cycle costs	187
9.3	Using standardised, off-site and modular systems	188
9.4	Maintenance needs	190
9.5	Emerging technologies	192
9.6	Case study: the future of tickets halls - Oxford Circus	194
—	More to come	196

## 10.0 Flashcards

10.1	Network station design type map	199
10.2	Central London Railway	200
10.3	Clark (city)	201
10.4	Clark (suburban)	202
10.5	District Victorian	203
10.6	Great Eastern	204
10.7	Great Northern	205
10.8	Great Western	206
10.9	Heaps (early)	207
10.10	Heaps (later)	208
10.11	Holden (Northern style)	209
10.12	Holden (Picadilly style)	210
10.13	JLE style	211
10.14	Late 1970's	212
10.15	Leslie Green	213
10.16	London, Midland and Scottish Railway (Upminster)	214
10.17	Metropolitan Victoria	215
10.18	New Works (pre WWII and post WWII)	216
10.19	Victoria line style	217
10.20	Whitechapel and Bow, LTSR and LNWR	218
10.21	2015 Palette	219

## 11.0 References

220

## Index

223





# A manifesto for good design

The heritage of high quality design throughout the Underground is evident for all to see. Great design, through the years, has (literally) put the Underground on the map.

The future of design on the network must expand upon and learn from this great history, to ensure the Underground's continuing success as it develops and grows in the 21st Century.



## In this section:

- Design Idiom principles
- Design matters
- Hierarchy of customer needs
- Capacity
- The Underground's design legacy
- Design Idiom opportunities
- The Design Idiom vision
- The ideal station
- At a glance
- How to use this Idiom





# **The Design Idiom principles should underpin design across the network.**

They should be applied to every style of station and every project, from small-scale patch repairs, to major refurbishments and new stations. They should be used as a checklist throughout the design process.

Applying the design principles from the start of each project will ensure high quality design uniformity and avoid unnecessary project delays.

Each principle is expanded into a chapter in the Design Idiom, with each giving instructions and examples of how to apply the specific principle. Each chapter can be read individually or as part of the whole.



**1.0**  
**Achieve**  
**balance across**  
**the network**

**2.0**  
**Look**  
**beyond the**  
**Bostwick gates**

**3.0**  
**Consider**  
**wholeness**

**4.0**  
**Prioritise**  
**comfort for**  
**staff and**  
**customers**

**5.0**  
**Delight**  
**and surprise**

**6.0**  
**Use materials**  
**to create**  
**atmospheric**  
**spaces**

**7.0**  
**Create**  
**ambience**  
**with lighting**

**8.0**  
**Integrate**  
**products**  
**and services**

**9.0**  
**Prepare for**  
**the future**



## ii. Design matters

**Well-planned spaces and efficient engineering help customers flow through stations, decreasing journey times and helping to deal with ever increasing demand.**

But we also want a customer's experience to be welcoming, uplifting and even inspiring – this is why design matters.

Great design goes beyond the functional. It also:

- Inherently helps users (often without them even noticing)
- Lifts moods
- Aids customer flows
- Makes moments to remember

The Underground already offers environments designed to brighten dull journeys and improve the travel experience: the 'thought of the day' from witty staff; classical music played at stations; Art on the Underground; and the wealth of great architecture.

We want more 'moments for the soul'; for every station to be remarkable in its own right, while still feeling like part of a whole.

Research shows that:

- Customer expectations are growing rapidly and we need to continue improving our service to meet them
- There is a significant relationship between high performing built environments and customer satisfaction and reputation
- Functional issues, such as decluttering, strongly drive customer satisfaction
- Emotional factors, such as lighting and reflecting local character, strongly drive reputation
- Further improvements to customer satisfaction and reputation depend on enhancing the quality of the customer experience, which positively influences things like the perception of journey time



01



02



03



04

**01  
BAKER STREET**  
Part of the original underground railway which opened in 1863

**02  
CHISWICK PARK**  
An example of a freestanding, circular station

**03  
SOUTH KENSINGTON**  
Designed by Leslie Green and built with the distinctive ox-blood red glazed terracotta tiled façade

**04  
WEST HAM**  
A more modern station with an impressive double height ticket hall



### iii. Hierarchy of customer needs

**The built environment has a significant impact on how customers perceive their journeys and contributes to their overall happiness and the Underground's reputation.**

In 2014, research was carried out into how customers' perceptions of the built environment affect their experience of travelling on the Underground. A mixture of quantitative and qualitative research, including accompanied journeys, was undertaken.

Customers experience the built environment through a hierarchy of needs. The most basic factors are feeling safe and having a sense of order, as the minimum expectation

is that they will be able to complete their journey safely and efficiently. Beyond this, there are additional elements that can enhance their journeys, but only if these basic needs are met.

There remain inconsistencies in the quality of our station environments at every level of the hierarchy, which undermine pockets of brilliance, and ultimately drag down the overall customer experience. The Idiom helps to address these discrepancies and hits every part of the hierarchy in order to deliver outstanding customer environments.

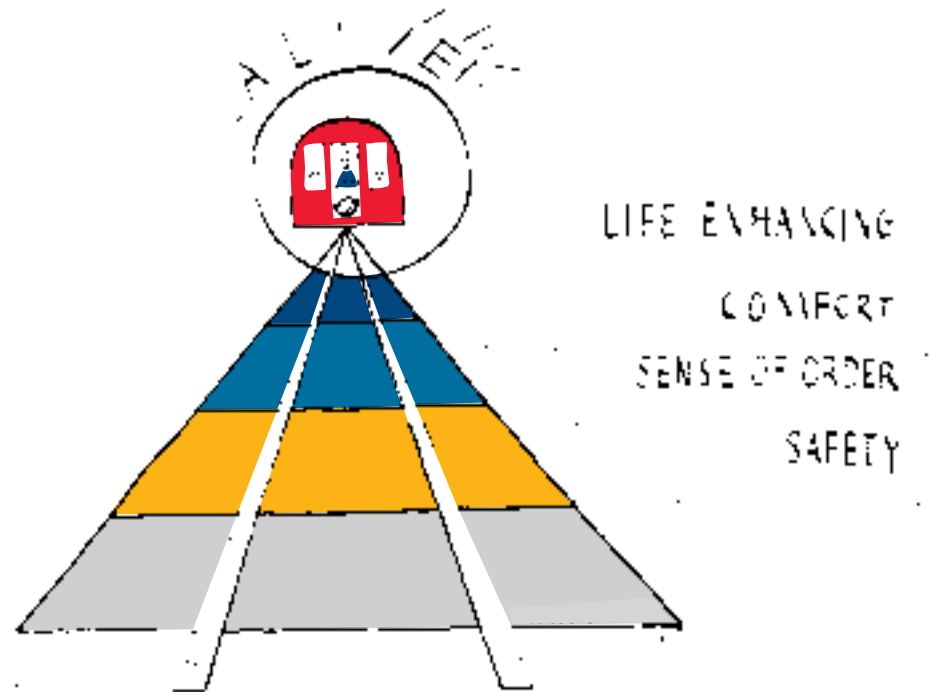



## iv. Capacity

### The importance of station capacity

London's population is forecast to increase by 1.7 million people from 2011 to 2031, with an additional 690,000 jobs over the same period. With employment growth concentrated in central and inner east London, and population growth spread across a wider area, accommodating a proportionate growth in travel across London by the TfL Rail and Underground remains a vital enabler.

Experience is that Rail and Underground demand remains robust and tends to increase even during economic downturns. Consequently, it is vital that the principles of good design are applied to all capacity interventions in order to optimise our customer environments and maximise journey time benefits.

The Underground has a strong programme of major station capacity upgrades and step-free access projects, the principal aim of which is to provide sufficient capacity to meet the forecast increase in passenger demand at priority locations over the longer term, to 2050 and beyond. The objective of the programme is to mitigate passenger congestion while reducing journey times and improving access at critical stations, like Bank and Camden Town, avoiding knock-on impacts to train services.

The importance of having a coherent long term view of the usage of the network is highlighted by modelling demand for transport services by 2041. Without any of our planned capacity interventions, there will be a decline in the overall level of service and significant crowding at a number of stations.

The Idiom works with future capacity interventions by ensuring that new or upgraded stations are spatially designed to aid passenger flows and minimise conflict points, and ensuring they have flexible spaces to accommodate future priorities. It also aims to make best use of existing capacity by maximising desire lines, decluttering customer environments, installing new lighting to promote intuitive wayfinding, and zoning customer and commercial activities.

Increasingly, major station projects are at least part funded by third parties, and may form part of larger developments. While LU must take advantage of any opportunities to increase the capacity of its stations this must not be at the expense of good design which meets out customers' needs and delivers the requirements of both LU and our commercial partners. The Idiom sets out the principles around designing these projects to ensure that additional capacity is not delivered at the expense of ease of use or the station identity.





01  
TOTTENHAM COURT ROAD  
Modernised station entrance designed to provide much needed capacity at this vital transport node. The monochromatic artwork seen in the photograph is by Daniel Buren, and is a transformative part of the station experience. Commissioned by Art on the Underground, London Underground.





## v. The Underground's design legacy

**Few could claim that the ambience, presentation and design quality of today's Underground matches that of the period of the company's 'golden era' of the early twentieth century.**

Successive piecemeal developments, initiatives and operational changes, as well as poorly conceived maintenance regimes, have occasionally been insensitive or blind to the overall station design and ambience.

This has resulted in a gradual accumulation of operational, customer and commercial 'developments' that sit uncomfortably with the original station architecture. The result is stations that look and feel compromised, constrained, cluttered and sometimes neglected. The images on this page show some of these poorly managed interventions.

This slow decline has occurred almost imperceptibly. Over decades, many of the special qualities and attributes for which the Underground's stations were once envied and emulated, such as their sense of space, order, clarity, and design quality, have been eroded. This has undermined the distinctiveness of London Underground's stations.

Recently, this decline has been arrested, and in many cases reversed. But, we can do better; the Design Idiom presents an opportunity to bring a defining and contemporary look and feel to our stations and create icons of the future.



01  
PATCH REPAIRS  
An example of a poor patch repair at Barbican

03  
MESSY CABLES  
Poor cable management suggests a disordered network

02  
SIGNAGE OVERLOAD  
Too much signage detracts from the key messages

04  
ACCUMULATION OVER TIME  
Clutter makes stations feel unordered and unclear





MAIDA VALE  
The beautifully designed  
clock and tile surround





## vi. Design Idiom opportunities

**Achieving excellence in design is about understanding balance, thinking about the whole, and considering different viewpoints to reach a better destination through dialogue and good communication.**

The Design Idiom presents an unparalleled opportunity to implement good design on the Underground. Good design involves:

- Creating a sense of order, comfort and security
- Delivering accessible environments for all
- Integrating stations with other commercial and community-focused uses
- Putting people's experiences at the heart of decision-making
- Encouraging customers and staff to value the stations they use

Only through good design and attention to detail can we create an environment which delivers a better service to an increasing number of passengers.

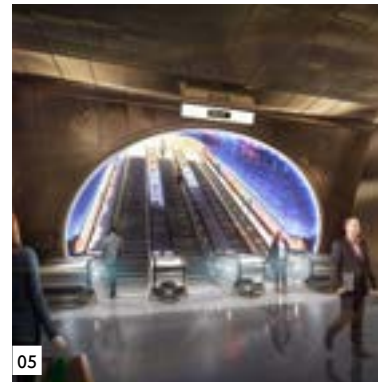
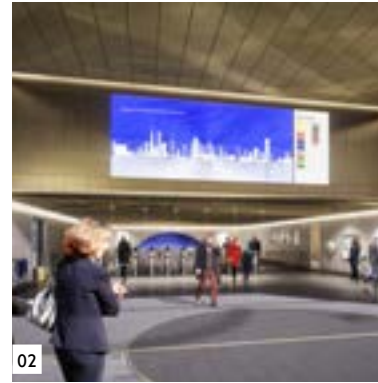

01 - 09  
THE FUTURE FOR LONDON  
UNDERGROUND STATIONS

Well-designed, atmospherically-lit stations with integrated commerce and other mixed uses





01

## Improve customer satisfaction and our reputation

By implementing the Design Idiom we will improve customer satisfaction and our overall reputation.

We must:

- Keep the Underground clear and clean – ambience is a key driver of satisfaction for staff and customers
- Ensure the Underground is well maintained – a ‘patch and mend’ approach, while fulfilling the immediate needs of the organisation, is not always enough
- Work together to create better managed and designed spaces

01  
LONDON UNDERGROUND  
STAFF MEMBER  
Satisfied staff improve the quality of the customer experience



02

## Meet the demands of an expanding business

Better organised space means quicker journeys. An attitude that ‘all space is there to be filled’ should not be the guiding mantra. Too many once useful customer spaces have been taken up by unnecessary equipment or initiatives. The ordered lofty spaces of the first half of the 20th century, designed by Charles Holden and Leslie Green, have been gradually compromised and the original perception of space lost. Passenger ‘desire lines’ are blocked, ‘dead’ spaces are created and intuitive movement is curbed.

02  
WAYFINDING  
Clear orientation is part of London Underground’s history



03

## Increase the feeling of security

Good design brings order and a sense of security. Our once celebrated stations have become increasingly tired, cluttered, badly lit and disordered. Close inspection of a London Underground station reveals a cacophony of signs, stickers, posters, whiteboards, floor markings, barriers, time pieces and dated products, many of which have little positive impact on our service. Customers are assaulted with a display of competing elements and visual clutter. The result is confusion, customer disengagement and a feeling of insecurity.

03  
FARRINGDON  
Tidy and well managed stations give a feeling of security



04

## Live up to the legacy

We must continue the design quality of the Underground’s past so that our brand and design history can be forever celebrated.

A single London Underground brand once permeated all aspects of the business, from the design of stationery to the architecture of station buildings. Take away the world-famous red and blue roundel, and a London Underground station was still instantly recognisable. The shape of the building, the flow of space, the quality of materials and products and the colour palettes all spoke of ‘London Undergroundness’. Since the Second World War there has been a lack of confidence in the Underground’s traditional brand identity; successive initiatives have compromised it under the guise of ‘progress’ and ‘freshness’. We aim to reclaim and improve this legacy.

04  
GANTS HILL  
Purity of form is amplified by good lighting



## vii. The Design Idiom vision



01

### 'London-ness'

London Underground's stations will continue to define the essence of London, representing the best of its rich heritage and contemporary culture.

London is one of the world's great cities and the Underground is part of its DNA. Look at any picture, postcard or film of London and the Underground usually features. The network's stations, services, brand, roundel and map are 'London' to residents and visitors alike. The Underground is the 'essence of London', a dynamic, contemporary, diverse city that is proud of its heritage.



02

### At the heart of the community

The Underground's stations will be the focal point of the community, commanding a distinctive presence within the surrounding environment.

London is a city of urban villages and diverse communities, and Underground stations are living, working entities at the centre of the communities they serve. The infrastructure and the services we provide are the lifeblood of the city and form the hub of many local neighbourhoods. The Underground at its best is 'the heart of the community' with bright, welcoming, safe, accessible and open stations that act as beacons of civility and metropolitan life; creating a civic focus and framework which makes London cohesive and functional.



03

### A showcase of London's distinctive architecture and rich culture

London has a unique architectural mix and tradition of urban design; nowhere else in the world boasts such a diverse set of buildings in a single location. London proudly exhibits ancient Roman and medieval remains, alongside the cutting edge of contemporary architecture. London's approach to architecture has never stood still and the Underground's stations reflect this diversity of design. Our stations provide a unique example of the history (and future) of station architecture and design.



04

### Clear environments with integrated commerce

The Underground's stations will be controlled environments, delivering simple, clean and uncluttered spaces with seamlessly integrated retail and commercial spaces, for the benefit of customers.

London is a vibrant city which revels in its diversity of neighbourhoods, cultures and experiences. The Underground provides an easy, familiar and reassuring way to navigate the exhilarating chaos of London's environment and provides access to shops, restaurants and commercial services en route. The Underground's stations, its brand and famous Tube map simplify London, making sense of the city through uncluttered, elegant designs and a consistent look.

01  
A COLLAGE CITY  
London is a city made from a collection of separate villages

02  
COVENT GARDEN  
The station is at the centre of this busy tourist area

03  
ARNOS GROVE  
Charles Holden's iconic architectural design

04  
CANARY WHARF  
Retail is seamlessly integrated into the large concourse



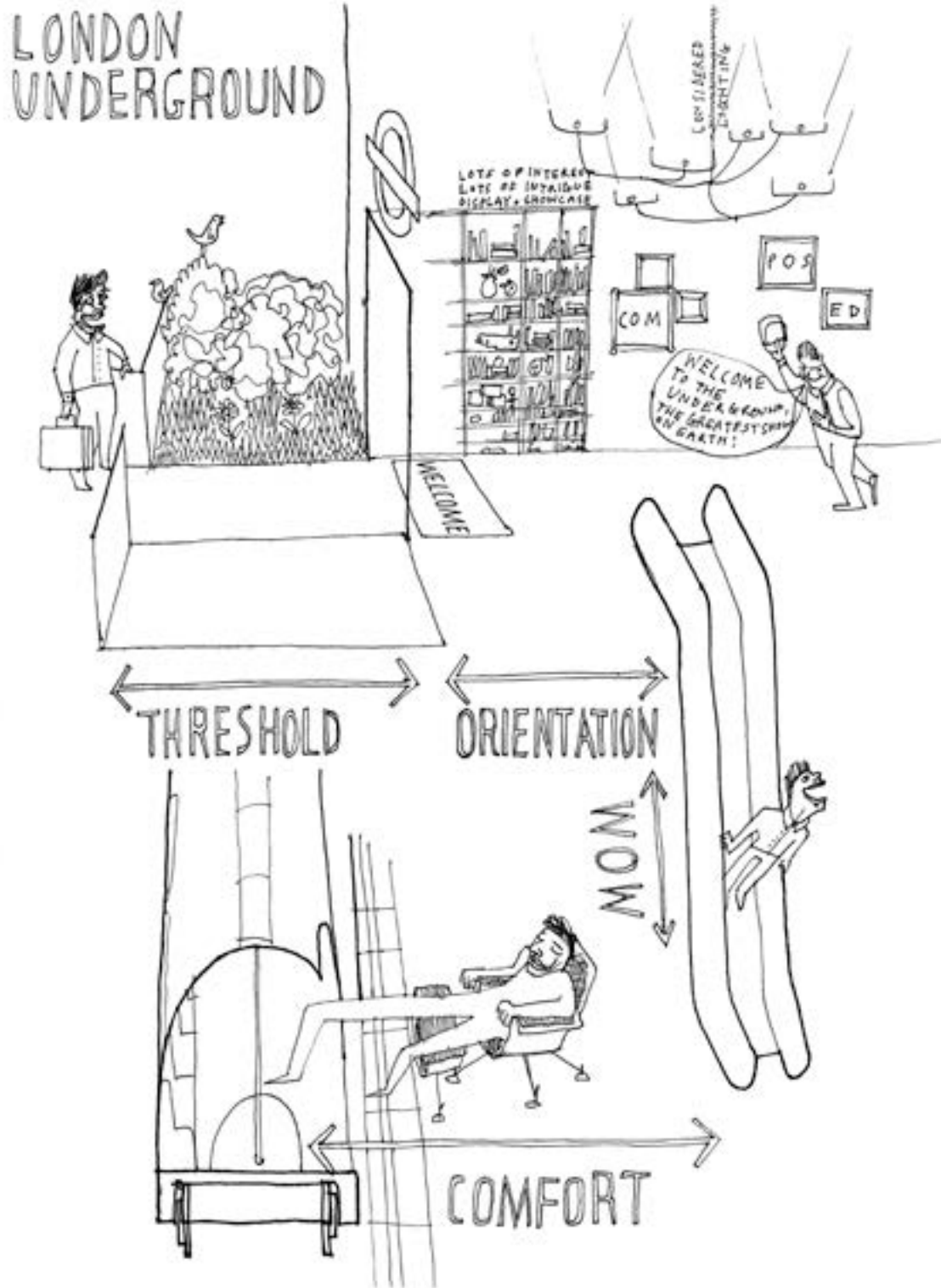



## viii. The ideal station

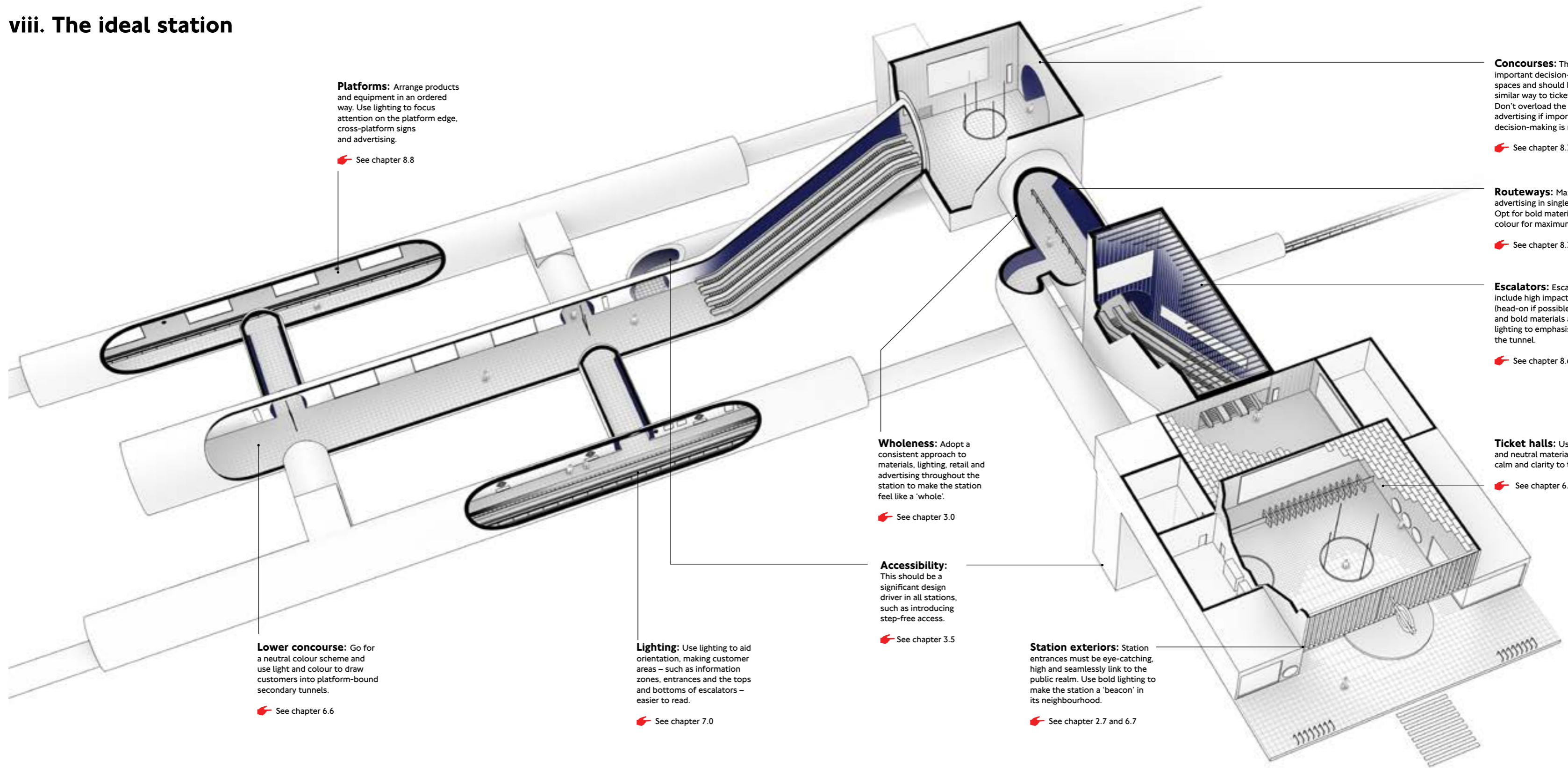

**Platforms:** Arrange products and equipment in an ordered way. Use lighting to focus attention on the platform edge, cross-platform signs and advertising.

See chapter 8.8

**Lower concourse:** Go for a neutral colour scheme and use light and colour to draw customers into platform-bound secondary tunnels.

See chapter 6.6

**Lighting:** Use lighting to aid orientation, making customer areas – such as information zones, entrances and the tops and bottoms of escalators – easier to read.

See chapter 7.0

**Wholeness:** Adopt a consistent approach to materials, lighting, retail and advertising throughout the station to make the station feel like a 'whole'.

See chapter 3.0

**Accessibility:** This should be a significant design driver in all stations, such as introducing step-free access.

See chapter 3.5

**Station exteriors:** Station entrances must be eye-catching, high and seamlessly link to the public realm. Use bold lighting to make the station a 'beacon' in its neighbourhood.

See chapter 2.7 and 6.7

**Concourses:** These are important decision-making spaces and should be treated in a similar way to ticket halls. Don't overload the space with advertising if important decision-making is required.

See chapter 8.7

**Routeways:** Maximise advertising in single routeways. Opt for bold materials and colour for maximum effect.

See chapter 8.7

**Escalators:** Escalators should include high impact advertising (head-on if possible), with immersive and bold materials and colour. Use lighting to emphasise the form of the tunnel.

See chapter 8.6

**Ticket halls:** Use natural and neutral materials to add calm and clarity to ticket halls.

See chapter 6.6



# ix. At a glance: station exteriors

**Natural light:** Design the station entrance to let in as much natural light as possible, with frontages and glazing maximised.  
 ↪ See chapter 7.11

**Lighting:** Lighting should be bright and welcoming and used to create a neighbourhood beacon.  
 ↪ See chapter 7.6

**Roundel:** Integrate the roundel into the station façade as a design feature.



**Retail:** Make sure shop fronts fit in with station environments.

**Station exteriors:** Station entrances must be eye-catching, high and seamlessly link to the public realm. Use bold lighting to make the station a 'beacon' in its neighbourhood.  
 ↪ See chapter 2.7 and 6.7

**Accessibility:** Ensure all thresholds are level and step-free where possible.  
 ↪ See chapter 3.5

**Entrance mat:** The mat should flow out into the public realm, to physically connect the station with its neighbourhood. It is also a safety feature which helps minimise dirt and water in the station.

**Entrance canopy:** The canopy is an extension of the station into the public realm, it should be semi-circular and provide shelter for those waiting to enter or exit the station.

**Station entrance:** Ensure the station entrance is clearly marked and that there is 'breathing space' of at least three metres around it.  
 ↪ See chapter 8.4

**Planting:** Use plants to add a sense of nature to station entrances.  
 ↪ See chapter 5.3

**Cycle hire:** Cycling is an increasingly popular form of urban transport. Encourage it with well-designed and integrated cycle parking.

**Security:** Stations should be open and uncluttered to aid natural surveillance. Make the station easy to close quickly and safely if needed.

**Public realm:** The public realm should be seamlessly integrated with the station. Include shared surface space, cycle parking and well managed planting. Good quality street lighting and materials should be used to underline the station's civic presence.  
 ↪ See chapter 2.4



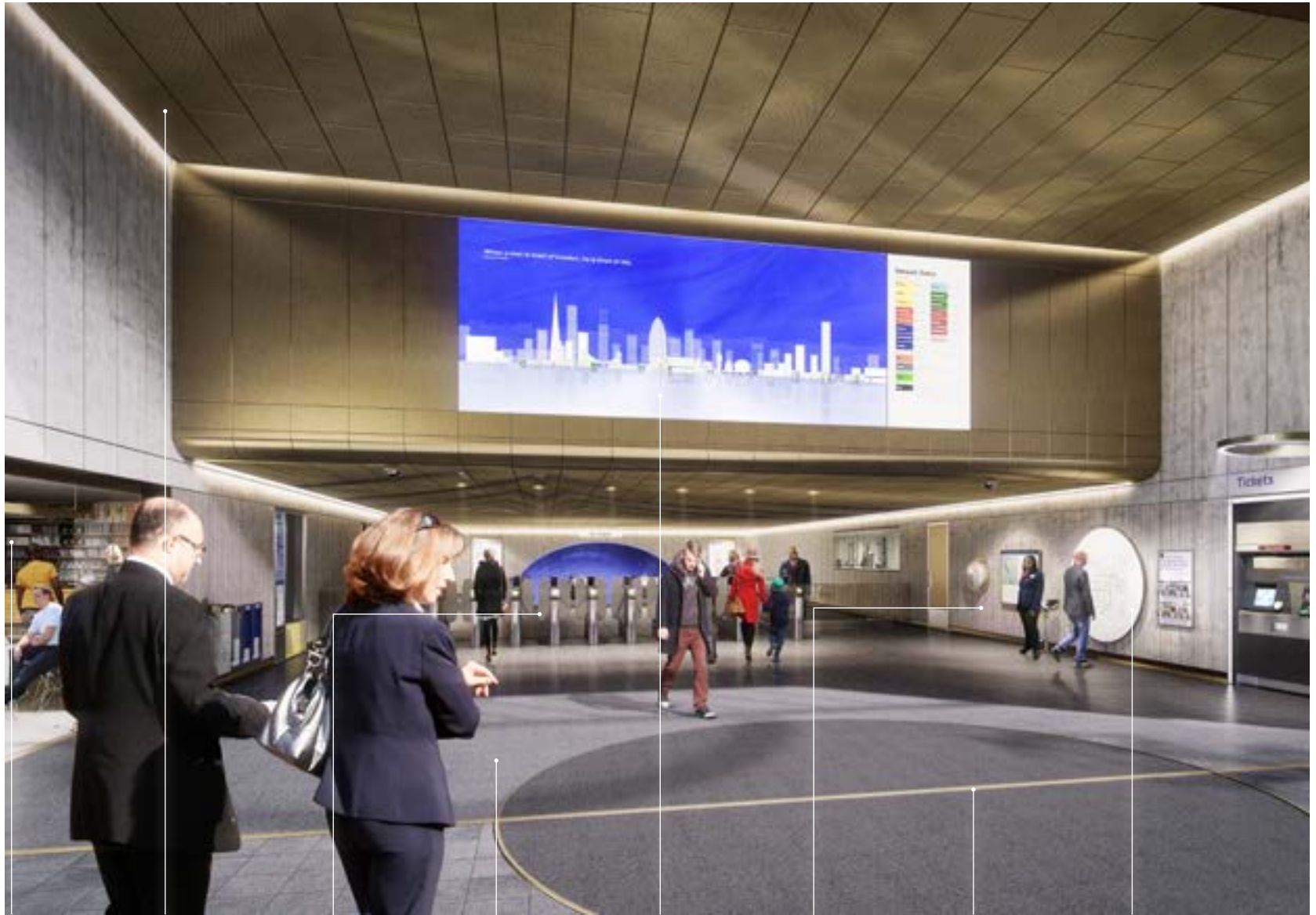

**Commerce:** Commercial uses such as shops, kiosks and photo booths should be integrated into the ticket hall, with inviting frontages. Ensure lighting does not compete with the ticket hall.

**Head height:** Maximise head height to create a greater sense of space.

**Gateline:** Use light to emphasise the gateline.

← See chapter 7.7

**Natural light:** Use as much glazing as possible to maximise natural light.

← See chapter 7.11

**Advertising:** Use large format head-on adverts if possible.

**Materials:** Use materials creatively to create atmospheric and not sterile spaces. In ticket halls these should be in calm and natural tones.

← See chapter 6.0

**Accessibility:** Ensure the edges of the spaces and any obstacles (such as columns) are highlighted using contrasting colours.

← See chapter 3.5

**Customer information:** Place customer information close to ticketing and at a good vantage point in the ticket hall. Use light to highlight the customer information area.



**Accessibility:**  
Use a dark floor material with contrasting skirting for visual contrast.

➔ See chapter 3.5

**Integrate products and services:** Integrate lighting, speakers and CCTV and their cables into the bulkhead and behind modular panels.

➔ See chapter 8.0

**Secondary routes:** Frame entranceways with light.

**Modular panels:**  
Use modular panels if possible.

➔ See chapter 6.9

**Lighting:** Use lighting that accentuates the curve of the space, concealing the light fixtures where possible.

➔ See chapter 7.8

**Materials:**  
Use contrasting textures to create atmospheric spaces.

➔ See chapter 6.0



## xii. At a glance: escalators



**Materials:** Use colourful and immersive materials, which contrast with the previous station space.

➔ See chapter 6.0

**Ambient lighting:** Use lighting to accentuate and celebrate the curve of the space.

➔ See Chapter 7.0

**Orientation lighting:** Use pools of light to highlight the top and bottom of the escalator.

➔ See chapter 7.3

**Functional lighting:** Integrate lighting within side panels of escalators.

➔ See chapter 7.9

**Advertising:** Use impact advertising, which runs the length of the escalator where possible.

➔ See chapter 8.6

**Glow of light:** Create a glow around the entrance portal to draw customers toward the escalator.





### xiii. At a glance: platforms



**Lighting:** Use concealed lighting to wash down walls.

➔ See chapter 7.10

**Skirtings:** Use covered skirtings, which are easy to clean.

**Products and services:** Arrange platform side products and services evenly to give a sense of order and rhythm.

➔ See chapter 8.8

**Customer information:** Zone customer information along the platform.

**Accessibility:** Use darker floor materials with a lighter contrasting edge for visual contrast.

➔ See chapter 3.5

**Platform edge lighting:** Ensure the platform edge is highlighted.

➔ See chapter 7.10

**Orientation:** Use a band of colour to highlight entranceways.

**Trackside line diagram:** Offset from platform entrance to encourage movement along the platform.

## xiv. At a glance: external platforms



**Accessibility:** Use darker floor materials with a lighter contrasting edge for visual contrast.

➔ See chapter 3.5

**Lighting**  
Use concealed lighting to wash down walls.

➔ See chapter 7.10

**Platform edge lighting:** Ensure the platform edge is highlighted.

➔ See chapter 7.10

**Canopy:** Extend the canopy to cover the platform edge.

**Customer information:** Zone customer information along the platform.

**Cabling and lighting:** Use the canopy to conceal cables and lighting.





## xv. At a glance: summary

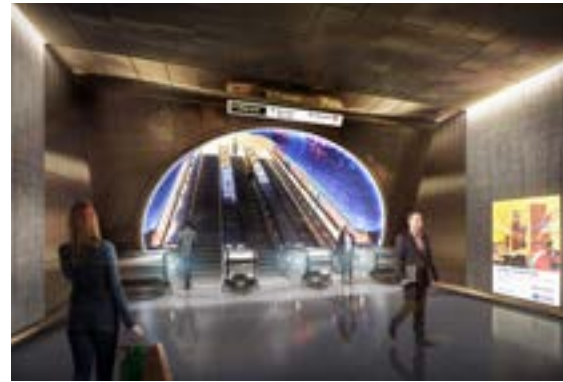
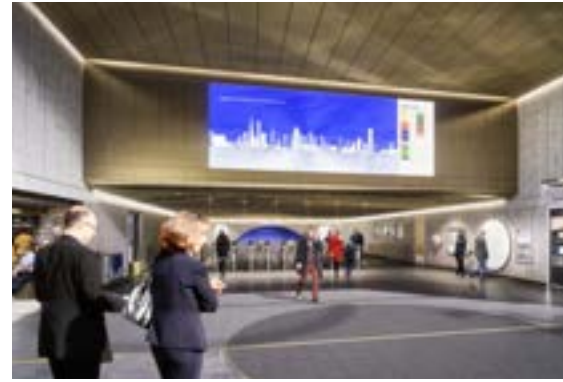

## xvi. How to use the Idiom

**The Design Idiom’s philosophy is one of common sense, asking the right questions, and thinking critically about how to apply it’s principles to a given location.**

**When considering a station intervention, big or small, you should step through each design principle enshrined in this Idiom in order to create a customer environment that will be both functional and delightful.**

The Design Idiom is about:

- Considering people – our customers, our staff and our key stakeholders
- Making the Underground travel experience better
- Underpinning and strengthening our brand and identity

The Design Idiom aims to ensure projects are considered as a whole, rather than in bits.

It is up to individuals, working together but led by the Design Idiom, to make intelligent and considered design decisions.

Much of the guidance will need to be tailored to the specific needs of individual stations, which are different and often idiosyncratic.

The Idiom is the Underground design manual, to be used when making all station-related design decisions. It works with existing London Underground standards and guidance.

➔ See chapter 11.0 for relevant standards and guidelines





**Good design should be the driver of decision-making, should permeate every level of the organisation, and should, ultimately, be celebrated by everyone. The Idiom is more than a set of principles; it is a philosophy, an attitude and a way of thinking. The Idiom promotes a joined-up, people-focused and design-minded Underground, the best network in the world.**

**Important things from this chapter to remember:**

- The new vision for the future look and feel of our stations
- This vision is supported by nine core design principles
- Design matters, which is underpinned by in-depth customer research
- Living up to the Underground's rich design legacy is important
- How to use this guide





# 1.0

## Achieve balance across the network

Good design is achieved through balance. For us, this means balance between heritage and the future, between a station's commercial activity and its customer information, and between the network as a whole and the station as a local place.



## In this section:

- The need for balance
- It starts with the roundel
- The whole brand
- Applying the principle of the circle and the rectangle
- Balancing network and local
- Visual balance
- Balance customer information with commercial opportunity
- Balancing heritage and the future
- Balance operational with ambience requirements
- Balancing engineering and aesthetic style
- Creating balance through hierarchy
- Case study: the application of balance
  - Camden Town station





# 1.1 The need for balance

## Good design must be balanced.

This is especially important in stations, where there are numerous and often competing sources of stimulation, from ticketing, signage and advertising through to retail. These spaces can be busy, noisy, distracting, confusing and, for some, overwhelming.

Through balance a greater sense of order and calm can be brought to stations. The different elements of any type of station space should not compete too strongly with each other or cause unnecessary distractions for customers and staff.

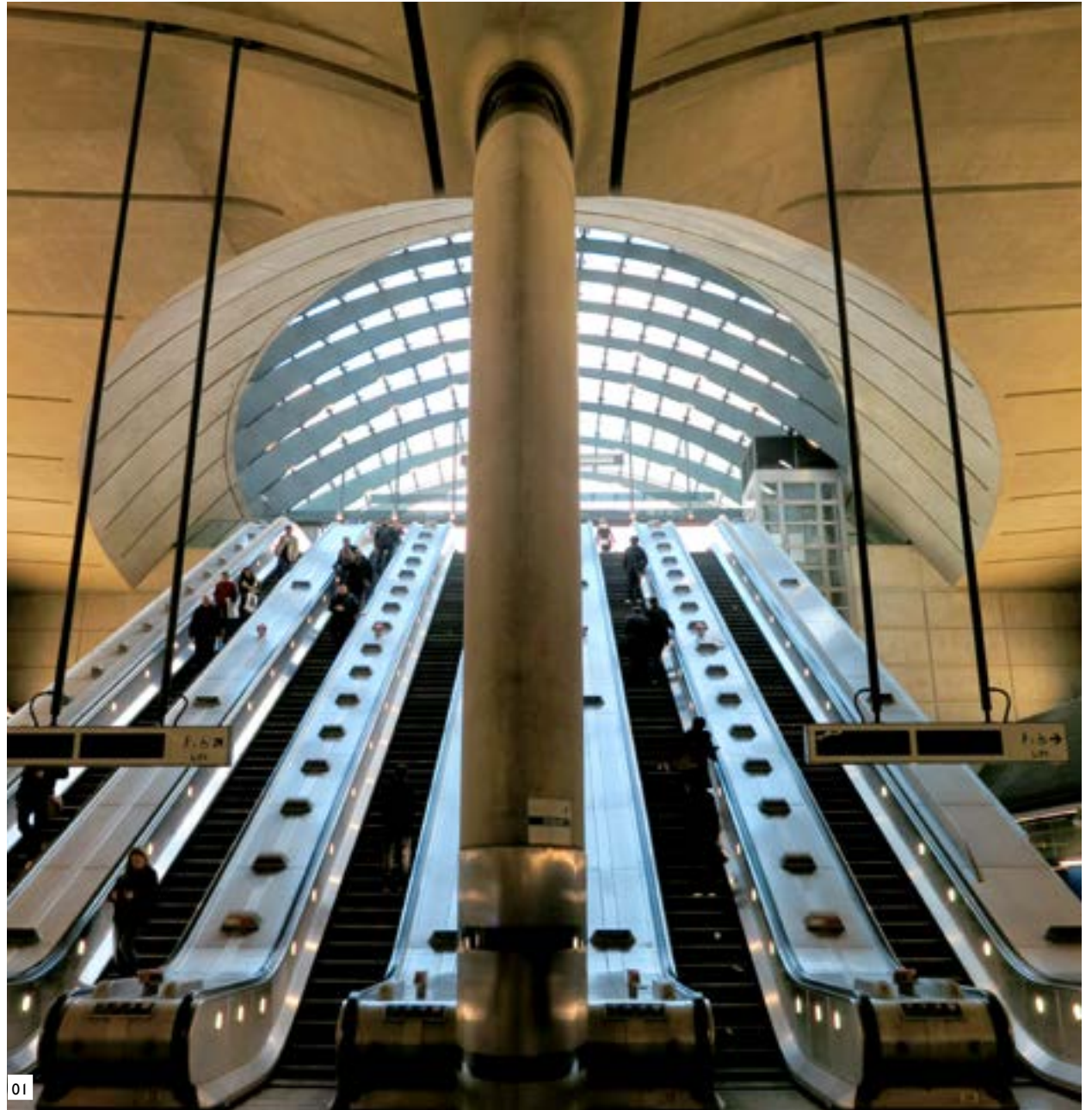

01

01  
CANARY WHARF  
Creates balance through  
order and generosity





01



02



03



04



05

01  
BOND STREET  
Network identity is  
balanced with a specific  
colour palette

02  
COCKFOSTERS  
Balancing a historic  
station with current  
operational needs

03  
WESTMINSTER  
Perfectly balances  
function with  
aesthetic impact

04  
CHARING CROSS  
Balances 'London-ness'  
and place

05  
OLD STREET  
Local identity balanced  
with the network



## 1.2 It starts with the roundel

**A symbol of unity across the network, the roundel demonstrates the balance between network consistency and local specificity.**

Its circle, which remains consistent from station to station, establishes the network identity while the name, which sits in the rectangle, changes.

The roundel developed from the need for the station name to stand out from competing information, with the red circle giving prominence to the name in the blue bar.



EALING BROADWAY

**Pre-1908**

A standard vitreous enamel nameplate as commonly used on Underground platforms.



**1908**

An early version of the Underground symbol appears as a nameplate on station platforms featuring a large red disk, known as the bar and the circle.



**1910**

Development of the word Underground on roundel as a logo for the network.



**1919**

Following Edward Johnston's modifications the 'bullseye' symbol evolves into a more familiar form.



**1933**

The roundel is adapted for use by the new 'London Transport'.



**1985**

The Underground version of the symbol, officially called the roundel from 1972, is designed by Henrion Ludlow & Schmidt.



## 1.3 The whole brand

**Alongside the world famous roundel, the Underground's brand and corporate identity draw on two other powerful elements. These are the 'Johnston' typeface and the Underground diagram or 'Tube map'.**

The typeface was commissioned from Edward Johnston in 1913 and the first version was delivered for use in 1916. Johnston was one of the most influential figures in twentieth century calligraphy and typography and his work, and this typeface, influenced many others such as Eric Gill and his 'Gill Sans' typeface.

Johnston's typeface, originally designed for wood block, has been adapted and modified over time, most notably in the 1980s, and will be re-issued in a more original version in 2016. The font, intended to be legible and calm, is often referred to as 'London's handwriting' and continues to do its job, adding a degree of recognition and reassurance.

The Tube map was developed personally by Henry Beck, better known as Harry, in the early 1930s and was not actually 'commissioned' by the Underground. It was first issued to the public in 1933 and was an immediate success – primarily as it produced a clear and consistent visual of the lines, where they cross, and the order of the stations, without the confusion of earlier, geographical maps which contained background information such as streets. The diagram is now world-famous, as a symbol of London and as an exemplar of graphic design. For the Underground it remains a primary tool for customer information and, with the line colours, forms part of a language of graphic information across the network.



01



02

01  
JOHNSTON'S TYPEFACE  
Johnston's typeface  
seen here in the new  
works at Earl's Court  
station c1937

02  
BECK DIAGRAM  
One of the earliest public  
issues of the Beck diagram  
from 1933





# 1.4 Applying the principle of the circle and rectangle



Circle



Rectangle



London Underground

**The combination of two shapes leads to a simple but fundamental framework that underpins the Design Idiom.**

## **Network consistency**

The circle should be used as a consistent network-wide aid for customers finding their way, defining customer information areas, ticketing, meeting points and lighting.

## **Local identity and flexibility**

The rectangle should be used for everything else, a locally responsive 'frame' for all other services from advertising to retail.

## **The circle and the rectangle**

The clear relationship between circle and rectangle creates harmony between the need to express the identity of the Underground network and for stations to be neighbourhood places.

## 1.5 Balancing network and local

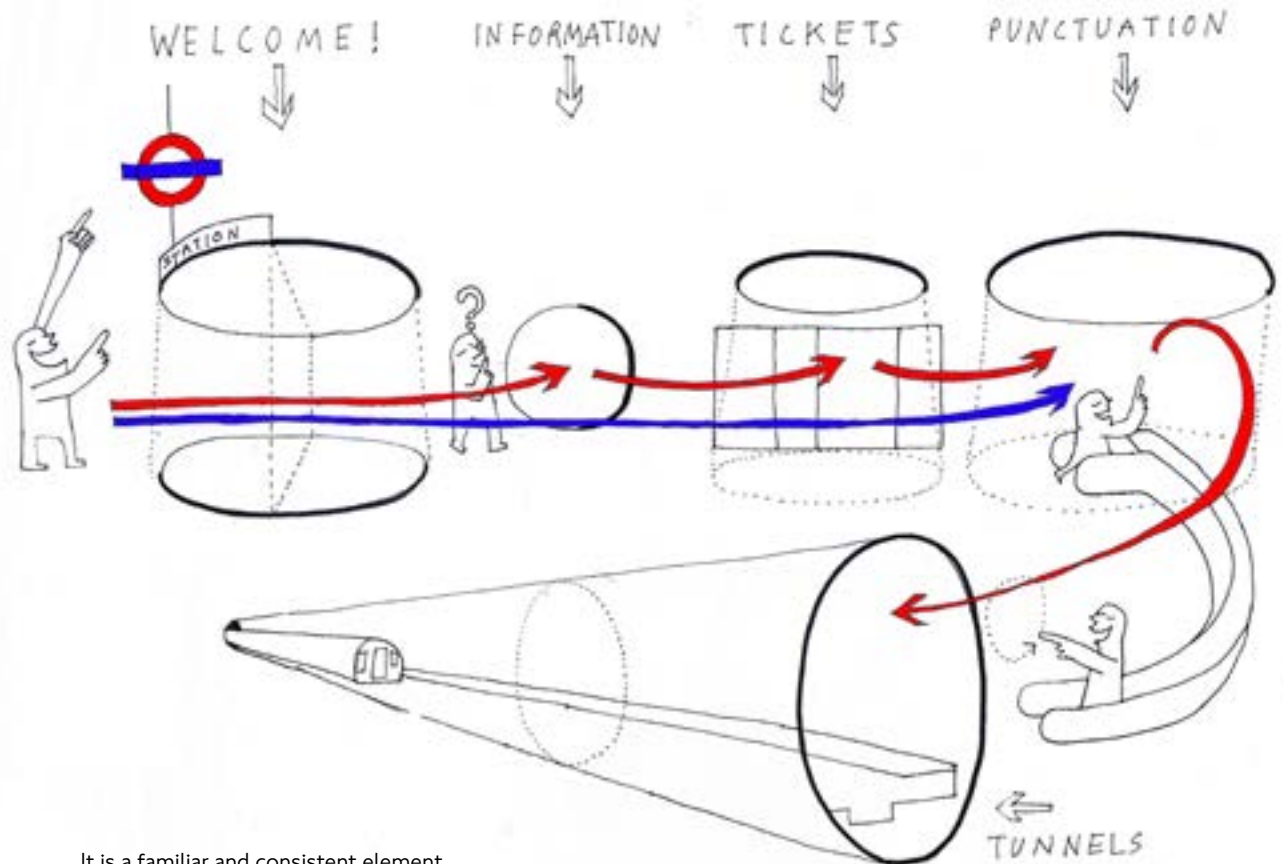

**The circle guides the customer through the station and across the network.**

It gives prominence to customer touch points, from the entrance mat and canopy to ticketing, customer information and onwards to the tunnels.

It is a familiar and consistent element, easily recognised in any station environment. It stands out and shows permanence, adding to a feeling of security and comfort for customers.

The rectangle represents the elements which change from station to station. The rectangle is the perfect frame for commerce such as advertising posters, retail shop fronts (permanent or 'pop up') and vending machines.

These images show the power of the circle as a customer focused feature.



Circular tunnel forming rings



Marketing messages using circular motif



Customer help point



ARNOS GROVE STATION  
Ticket hall



ARNOS GROVE STATION  
Circular ceiling



TRANSPORT COLLECTION  
The London Transport Collection,  
Tom Eckerley, 1975

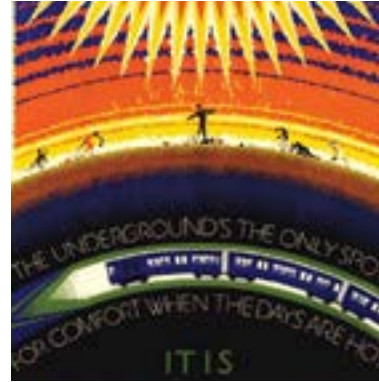

IT IS COOLER BELOW  
Underground poster



TOTTENHAM COURT ROAD STATION  
Circular floor tiles



LABYRINTH  
MARK WALLINGER  
A major artwork commission for all 270 stations to mark the 150th anniversary of London Underground



COVENT GARDEN STATION  
Historic roundel



SOUTHGATE STATION  
Escalators



LU LOGO  
Detail on seating



These images show the power of the rectangle as an adaptable 'frame' for commerce.



FINCHLEY CENTRAL  
Online collection point



VICTORIA  
Shopping arcade



HAMMERSMITH  
Retail kiosk



WESTMINSTER  
Platform edge door advertising



BLACKFRIARS  
Advertising poster frames



SHOREDITCH  
Boxpark retail units



BUCKHURST HILL  
Click and collect collection point

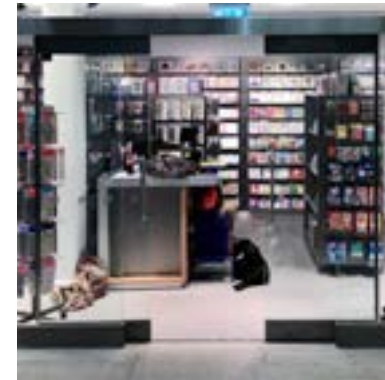

CANARY WHARF  
Retail units



ANGEL  
Trackside advertising

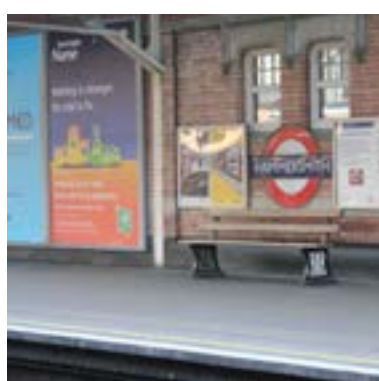

HAMMERSMITH  
Platform side advertising



55 BROADWAY  
Retail kiosk



WATERLOO  
Retail kiosk

## 1.6 Visual balance

**Understanding which element in a given space should be prominent and which should be more recessive achieves visual balance.**

It is easy within a changing station environment for the growth of new and old elements to create visual confusion. Grouping similar activities and creating 'breathing space' between them avoids this.

Considering the elements within an area, so they are evenly spaced, will add a natural order and calmness.

➔ See chapter 8.0 for further information about products and services



01

01  
SOUTHWARK  
Visual balance is achieved  
by creating breathing  
space between elements



## 1.7 Balance customer information with commercial opportunity



01

01  
VICTORIA UNDERGROUND  
STATION, 1900  
The roundel developed  
from the need to stand  
out against commercial  
competition

**It is important to achieve the right balance between the amount of customer information, retail and other commercial units, and advertising.**

Thought should be given to customer needs so that station spaces do not feel dominated by one thing. For example, a station crammed with retail or advertising will be hard to navigate and distracting for customers. Conversely a station with no retail could represent a loss to a customer's sense of convenience. A smaller amount of well-placed advertising is more valuable to advertisers – and therefore London Underground – than a lot of less prominent advertising.

Imagine a platform with nothing to look at while waiting for a train – or the opposite, a station filled with customer and safety information (risking increasing a customer's anxiety about their journey).

To strike the right balance, these elements must be considered on a station-by-station and space-by-space basis.





# 1.8 Balancing heritage and the future

As the Underground develops, it must continue to be at the forefront of design and technology while preserving and celebrating its heritage assets.

This means:

- Having knowledge and understanding of the 'design DNA' of the London Underground
- Maintaining, preserving and enhancing its heritage assets
- Introducing new technology, systems and greater accessibility in a way that does not detract from the character, appearance and integrity of its historic stations
- Designing new facilities and stations to live up to the design and architectural legacy of the past
- Meeting or bettering the historic quality of materials and their craft
- Working closely with our partners in borough planning and conservation departments, English Heritage and the national and local heritage and amenity societies

Listed building consent is required for any alteration or addition to Grade I, Grade II and Grade II\* listed stations on our network. You should seek internal heritage advice and talk at the earliest stage with the local planning authority conservation officer and in certain cases with English Heritage.



01  
FARRINGDON  
Replacement train shed roof follows historic design but in modern materials

02  
EARL'S COURT  
A modern lift provides step-free access within this listed building

# 1.9 Balance operational with ambience requirements



**The operational needs of the organisation should be considered alongside station ambience.**

Customers will respond positively to well-designed spaces which feel welcoming, safe and secure, making the operation of the station easier.

- Customers should be consistently satisfied with every aspect of their last journey
- The service must be integrated, accessible and inclusive
- Safe, secure and welcoming environments will improve operations
- Journeys should be reliable and faster
- Information must be sufficient and timely
- Stations should have a sense of drama while also being easy to navigate



01  
SOUTHWARK  
A station designed to maximise customer comfort and security by minimising the complexity of the station. Naturally lit, the station respects the engineering and creates harmony through the use of materials

02  
KING'S CROSS  
Full Circle, Knut Henrik Henriksen, art project, London Borough of Islington. Commissioned by Art on the Underground, London Underground. Photo: Daisy Hutchison







01

## Everything a customer may see during their journey should be considered from a visual perspective.

A well-engineered solution, temporary or permanent, may need to be adapted to be aesthetically appropriate.

A few points to bear in mind:

- Consider how the solution will look and the impact it may have on customers
- Ask if the solution may be easily adapted to be visually expressed and special, or if it can be easily concealed
- Minimise adverse effects on customers through good planning and management

For example, a well-engineered solution to running cabling may be to run it trackside along a platform or in an exposed location so that it is easy to access, inspect and maintain. However, many customers may feel uncomfortable being in such close proximity to cabling. A simple solution would be to conceal the cabling behind a cladding system with accessible panels.

01  
WESTMINSTER  
A highly engineered station which functions well and looks beautiful





## 1.11 Creating balance through hierarchy

**Considering the composition of elements in a station and establishing their hierarchy in each space will enhance clarity, help people find their way and create a sense of order.**

The importance of each element should be decided first. This will determine which should be the most dominant and which space should be recessive.

Follow these rules:

**Get the proportion of customer information to advertising and retail right early on**

**Consider the ratio of visual stimulation to calmness in each space**

**Safety information and equipment should always take precedence. But too much in highly prominent locations can cause anxiety, so make sure it is appropriate**

**Customer information should be the primary focus of ticket halls, platforms and at decision-making points. Thought should be given to the amount of information available**

**The type, size and location of advertising should be considered, so that customers are not overly distracted from what they are doing**

**Other commercial opportunities (retail or cash machines for example) should be located to maximise their footfall without interrupting passenger flows**

 See chapter 8.0 for further information



# 1.12 Case study: the application of balance

## - Camden Town station



01



02



03

The Camden Town station extension will need to establish a series of balances:

- Customer information and signage with new retail spaces
- The heritage of the existing station with the design of the new station entrance
- The engineering requirements of the station with its aesthetic needs
- The consistency of the Underground network with the local area

Careful consideration was given to how the 'tidemark' between the original station and the new area would be designed. The datum lines of the original tiling design have been carried from the old station into the new with a large black skirting area reflecting the tiled skirting of the original station and the new cladding panel modules aligning with the tiling line of the old concourse.

We asked: what makes Camden special and memorable? We researched the history of the area and station, and looked at what would be happening around the station extension in the near future.

With this in mind, we developed a public realm design which incorporated the themes taken from the original station and a music-focused retail venue in the disused vent shaft, an area devoted to performance.

Inside the station we used circles to denote customer touch points, such as information and ticketing, and large rectangular forms to accommodate the retail uses and advertising.

01  
CAMDEN TOWN  
EXTENSION  
Blending the old  
with the new

02  
ESCALATOR  
With circular  
lighting feature

03  
ENTRANCE AND  
VENT SHAFT  
A new music  
focussed  
retail use



**The Underground's environments are complex and often space constrained. While primarily there to enable and ease movement through the network, they also perform other functions, like being world-class commercial destinations. It is vital to strike the right balance between, sometimes competing, priorities – and maintain a purity and clarity of space to create a sense of order and calm.**

**Important things from this chapter to remember:**

- Use circular forms to guide customers through stations
- The circle represents network consistency
- Retail environments and advertising often prefer rectangular forms
- Strike the correct balance when trading off competing priorities
- Stations will have different priorities
- Retaining a sense of purity and calm to spaces is vitally important





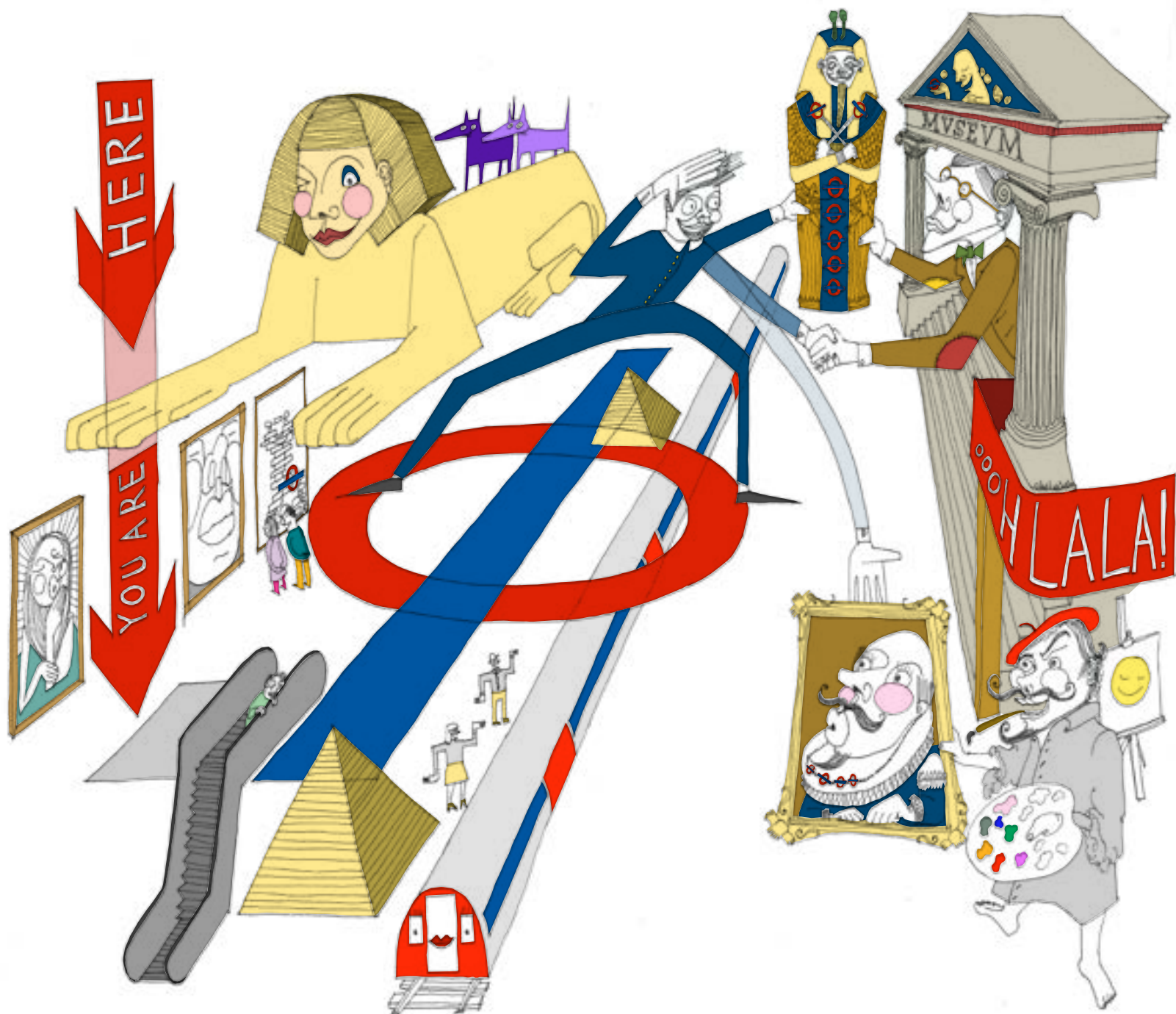

# 2.0

## Look beyond the Bostwick gates

Stations are more than portals to the Underground; they are also places to meet, eat, shop and, most importantly, they are centres of community. Many people's mental map of London is organised by Underground stations. A neighbourhood's identity can be enriched by truly 'embedding' its station in the local area.



## In this section:

- Stations designed for their place
- Stations designed for people
- Integrating stations into the local area
- Linking stations to the public realm
- Linking stations with local history
- Station communities and retail
- Station façades and frontages
- Station portals and subway entrances
- New stations
- Interchanges with other modes of transport
- Case study: knitting a station into its place
  - Southgate station





## 2.1 Stations designed for their place

**The 'place' is often a reason why people travel to an area, and this should be considered first.**

- Think 'beyond the Bostwick gates' to weave it into its neighbourhood so that it engages with its 'place'
- Understand the place to identify the station's role within the wider London context
- Understand the main features or functions that attract people to the place and how station and public areas can be changed to better support the locality
- Promote and celebrate the Underground's commitment to a positive civic scene

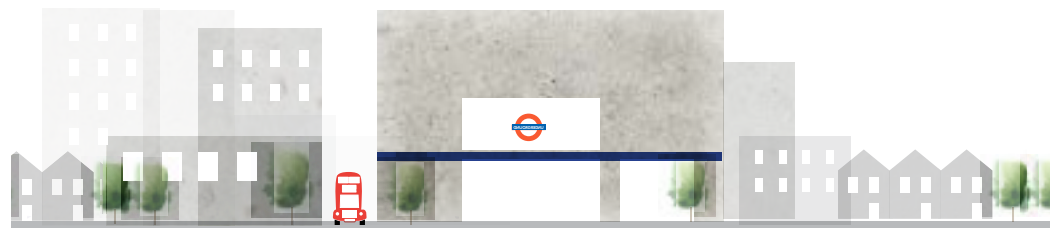
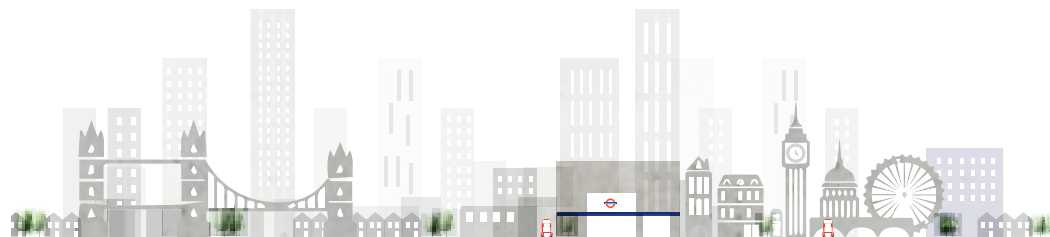
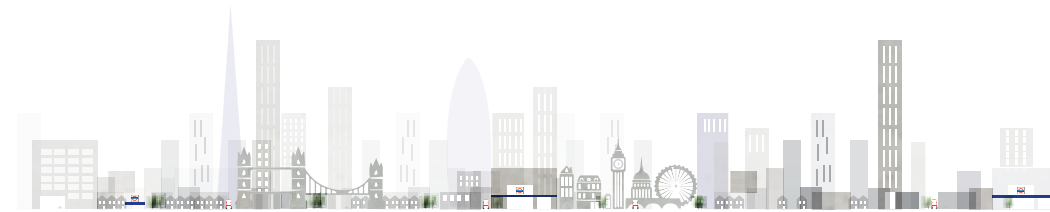



01



02



03

Places don't stay the same, they evolve, so when assessing a place and the station's role within it, recognise how the area is likely to change. An idea of how a place could change can be developed from several sources including:

- Planning applications
- Development proposals
- National and local planning policy
- Aims of local stakeholders, businesses and community groups

### Three questions should be asked in order to place the station in the centre of its locality:

1. What types of people use the station?
2. What type of place does the station serve?
3. How could the area change in the future?

01  
CHARING CROSS  
The subway entrances  
provide clear access from  
all around Trafalgar Square

02, 03  
INVOLVING COMMUNITIES  
As places evolve, it is the  
people who live, work and play  
there who must be involved



## 2.2 Stations designed for people

### The key to any station design is the people it aims to serve – its customers, staff and the local community.

Think beyond the station infrastructure and consider all the different people that may use the station and their varying needs:

- The daily commuter
- The weekend leisure user
- The tourist
- The shopper
- People needing services such as cash points
- Those wanting wider London transport services/ticketing and information
- Those seeking London attraction tickets and services

Different stations often have customers with different needs and expectations. A station should respond to those requirements while understanding the needs of the wider local community. On this basis, stations have been categorised into four broad types:



01

### Gateway stations

A Gateway station is a point of arrival into London. The station will be many people's first experience of London, so it should be an exemplar and cater to those specific customer needs.



02

### Destination stations

A Destination station serves a significant destination within the local area. It is usually the end point of a journey and so local organisations, institutions and the public realm outside the station need to seamlessly connect the customer with the destination.



03

### Metro stations

Metro stations are intermediate stations, normally close to or within local centres. They often act as focal points or interchange hubs in the local area. Considering how best to achieve integration with the community and the place is crucial.



04

### Local stations

Local stations tend to be smaller and often serve a narrower commuter base or defined local community. People tend to live near local stations and know the station well. Social and place-making objectives are important when thinking about the role the local station can play in these communities.

01  
PADDINGTON  
A gateway station

02  
STRATFORD  
A London destination

03  
HAMMERSMITH  
A metro station acting as  
a local area hub

04  
WOODSIDE PARK  
A station serving the  
local community





## 2.3 Integrating stations into the local area



01

**The experience of many places in London often begins at the station. That sense of place should start at the platform, the moment you arrive.**

Customers travel to a range of destinations in a local area from Underground stations. These include functional, recreational, workplace and residential destinations.

- Relate the underground spaces to the areas above them, whether streets, squares, park or river
- Position entrances towards main areas, routes and destinations
- Use signage and maps to clearly identify with the local area
- Signage must be integrated into a station and considered as any other part of the design. Information to help you find your way should never be added as an afterthought
- Permanent messages should be integrated into stations. Space for temporary messages should also be provided



02

**01 EDGWARE ROAD**  
An innovative 200 square metre green wall designed to trap pollution on one of London's busiest roads

**02 OLD STREET**  
Wayfinding system that takes you from ticket hall to street level. An immersive colour wrap and numbering system has been added to aid navigation, in an energetic design that responds to the tech-based locality



03

**03 STRATFORD**  
Attraction signage connecting the platform to local attractions



## 2.4 Linking stations to the public realm

### **A station supports the local area and the local area should support the station.**

We must extend the traditional boundaries of stations, making internal spaces seamlessly merge with external environments. Stations should be more socially engaging.

A station should directly connect to established local institutions that have particular meaning and longevity, such as art galleries, museums, major retailers or attractions. However, it is crucial that flagging up local highlights does not disrupt the smooth running of the station. The best place for this type of intervention is at platform level where a 'place begins at platform' concept can prevail.

A station must:

- Be easy to find in a busy street. Strong architecture and a good location help a station to be a beacon in its environment
- Connect seamlessly to the local area
- Have illuminated entrances, canopies, signs and roundels to celebrate the station's importance as a local landmark
- Make the most of the public space outside a station to make it stand out and give customers a chance to pause before or after travelling. These public spaces will create centres of urban activity and attract more people and increase retail and advertising opportunities on the Underground
- Have a well-designed ticket hall, where consideration is given to the most popular pedestrian routes and the external spaces
- Have pavements outside that are wide enough to make it easy for customers to access it

➔ See TfL Public Realm design guidance (2015)

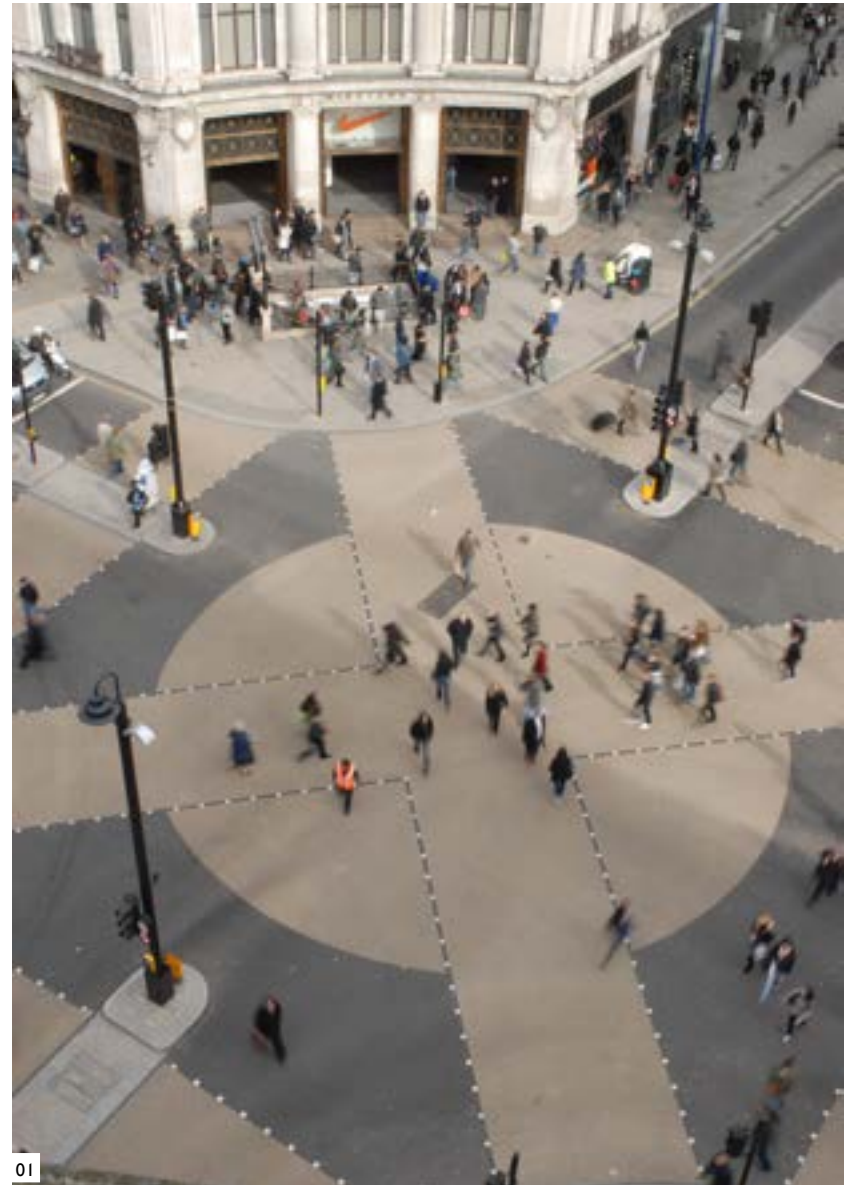

01

01  
OXFORD CIRCUS  
Underground station  
directly connected to  
diagonal crossing above







01

01  
SHEPHERD'S BUSH  
Public space outside  
the station

## Public realm design

The design of public realm spaces should be coordinated with the local authority, stakeholders and neighbourhood groups, so it is important to work together to attract people to the public spaces around the station and ensure their safety through natural surveillance and security.

Good lighting of the public realm around a station helps it to stand out in the local area and can enhance a customer's journey.

Promote staff involvement, ownership and pride in the local area and develop a 'toolkit' for operational staff to help them better engage with the community and their customers.

The Underground in Bloom competition is a fantastic example of how staff lift a station's environment and blend the inside and outside spaces.

## Three questions should be asked when considering the threshold and outward expression of the station and its public realm:

1. Has the station's 'street presence' been maximised and if not, how could it be?
2. Has a positive relationship between the ticket hall and the public realm been forged?
3. Has the opportunity to work with an established local institution been explored to make the station experience more interesting?





## 2.5 Linking stations with local history

### Engage with local history and the history of the station wherever possible.

Throughout the Underground's history, 'local' details have been designed into the station fabric. This has been achieved through a multitude of design, from permanent sculptures, through unique tiles, to creative murals, and local history plaques.

Relate the station's public realm to its history and context. The individual details of each station – such as historic materials, tiles, lighting, shapes and colours in the landscape and public realm design – should be highlighted.

➔ See LU standard I-355 Listed Buildings and other structures of historical importance



01



02



03



04

01  
BAKER STREET  
Image of literary character Sherlock Holmes, whose home was at 221b Baker Street

02  
EAST FINCHLEY  
The Archer at East Finchley refers to the historic local hunting grounds

03  
CHARING CROSS  
Panels at Charing Cross tube station showing the area's complex history

04  
BAKER STREET  
Historic faience memorial at Baker Street



## 2.6 Station communities and retail



01



02



03



04

01  
KILBURN  
Retail at Kilburn  
station in 1935

02  
FLAT IRON SQUARE,  
SOUTHWARK  
Retail in the  
public realm

03  
KING'S CROSS  
Lola's cupcake kiosk

04  
CLICK AND COLLECT  
Shopping  
collection service

**Shops at stations should reflect the communities they serve.**

Consider the following:

- Stations and their public realm are primarily civic spaces
- Shops should bring the local community into the heart of the station
- Nearby retail services should be encouraged to become part of the overall travel experience
- Internal, external and semi-external retail environments should be used to bridge the gap between inside and out
- Retail and commerce should not obstruct the movement of passengers



## 2.7 Station façades and frontages



01

### **The façade of a station, as well as its entrance, can have a great impact on the public realm.**

A building's edges are made up of façades and frontages and can involve a range of uses and treatments. The relationship between the public realm and a building's edges need to be considered carefully.

The following should adhere to:

- Make the most of frontages, and ensure the station entrance takes prominence over station retail. Ensure that the station entrance has the most prominent position from an urban planning perspective. A station entrance in the middle of a high street stands out better than one in an arcade
- Stations often have inactive and blank façades which can attract antisocial behaviour. Where these can not be avoided, they should be comprised of high quality materials or green walls and should avoid deep recesses or corners
- Station entrances, especially within over-site developments, should have at least double storey elevations
- Station entrances are important focal points, so any design should embrace the local character and sense of place, while providing a consistent streetscape along its perimeter, linking effectively with the surrounding streets

➔ See chapter 6.7 for further information

01  
GREEN PARK  
Green entrance façade







01  
PICCADILLY CIRCUS  
SUBWAY ENTRANCE  
An example of a clear, visible  
subway entrance with integrated  
signs and lighting

02  
KNIGHTSBRIDGE  
An enclosed subway entrance to  
an underground ticket hall

### Subway entrances

Some Underground stations have no buildings at street level and can only be accessed by independent subway entrances or via public subway systems. However, they should still be easy to find and use and be as clearly recognisable as any surface-level building. It is important to make such entrances as welcoming as possible to ease feelings of danger sometimes associated with poorly designed subways. Keep the subway routes between the street and ticket hall as short and straightforward to use as possible.

Many subway entrances are not owned by London Underground, so work with subway system owners on the design of the passenger route. Where possible they should:

- Be covered to provide weather protection
- Be step-free and accessible to all
- Be well and consistently marked and signed as station entrances, with prominent use of the roundel
- Have enough space for signage, including customer information and the range of station services
- Not be obstructed or compromised by stallholders, street vending or unauthorised traders

- Use light to ensure they are both focal points and inviting entrances to the system
- Be big enough to cater for the number of passengers who use the station
- Ensure disabled people are considered, and include colour-contrasting handrails, stair-treads and risers.

The design should also consider local site constraints and context such as:

- Adjacent roadways and pavement provision
- High-level use of glazing and services provision to minimise onerous maintenance requirements and access issues
- Local streetscape design and opportunities

### Over-site developments

Consider opportunities to develop space around stations for other uses which add value and improve the sense of place. Remember the station's role as a beacon within the community and ensure that the entrance has a strong street presence and the ticket hall has plenty of open space.

- The station should be the dominant street-level feature (not the over-site development)
- A station should be easily identified as a station, even without the need for the projecting roundel
- A station entrance should be at least two storeys high
- Nature should form a key design element of any station exterior if possible, through tree planting or the addition of green roofs or walls
- The station entrance 'frame' should stand out and ideally the canopy should project into the public realm
- The station lighting should distinguish it from its adjacent (often retail) frontages
- The station frontage material should be distinct from the over-site development facing material

← See chapter 6.5 for further information

### Freestanding stations

Given the increasingly rare opportunity that a new station will be freestanding, whenever possible it should be circular.

There is a wonderful history of freestanding circular stations within the Underground network. The circular form generates a sense of invitation from all sides, maximises accessibility and is better for sight lines and surveillance. With freestanding stations, it is essential to create a generous double-height ticket hall and to maximise transparency and openness to allow views through.

It may not always be possible to create a pure circular form owing to site constraints, but other distinctive and interesting plan forms – such as hexagons or octagons – can be used.



01  
CANNON STREET  
A station integrated within  
an over-site development

02  
SOUTHGATE  
An exemplar circular  
freestanding station

## 2.10 Interchanges with other modes of transport



Underground stations often interface with other modes of transport, including:

- Rail stations – London Overground, Docklands Light Railway
- Bus stops and stations
- Tram stations
- River boats and piers
- Taxi ranks
- Cycle parking hubs and cycle hire
- National Rail

Stations should have a distinctive separation in design from other modes, while maintaining continuity through customer information, posters and signage.

Flag up any popular destination within 200 metres of the main station and provide for higher numbers of people passing through.

Wherever possible, include features to improve accessibility for people who are disabled, carrying luggage, pushing prams or buggies.

The street often acts as an interchange zone – a multimodal hub and public space where people meet, walk, cycle, drive, park and catch buses. Ensure pedestrians can move easily and safely between different transport modes, without impeding the smooth running of public transport services.



The interchange with these other modes should be simple, with intermodal distances kept to a minimum. Access routes to bicycle storage, car drop-off areas and car parks must be clear, easy and safe to use. Place information about onwards services and local destinations in prime locations. If changing from one form of transport to another involves a customer leaving the station, organise the station to make the most of the flow of people.

➔ See TfL Interchange Best Practice Guidelines (2009)

01  
PLAISTOW  
An interchange  
between bus and Tube

02  
VAUXHALL  
Using signage to illustrate  
the range of transport  
available at a location



## 2.11 Case study: knitting a station into its place – Southgate station

Southgate station, designed by Charles Holden, is a wonderful example of a freestanding circular station with integrated retail and considerable public spaces. It is a good example of how a station can become a neighbourhood hub.

The station's original design was pioneering, functional and iconic; combining dramatic lighting and thought-provoking shapes with well designed passenger flows and an understanding of the ground level landscape. Over time, however, this sense of place has been eroded, and a lack of regular maintenance and piecemeal additions to the station have made it less user-friendly.

We have put this Grade II listed station back where it belongs – as the true heart of Southgate. The new design provides community uses and retail and an improved public realm to make it a truly integrated public transport community hub. We moved the bus stops to a shared space to the east of the station and created a peninsular of the existing roundabout. This has produced a generous public space where we have installed retail kiosks and cycle parking. The station could become a catalyst for change in Southgate.



Just as the original design was a pioneer of its time, the restored and revitalised Southgate station could be a prototype for the future of metro stations as local hubs, working together with English Heritage and the local authority and with the combined support of all London Underground departments.



01  
SOUTHGATE  
An artist's impression  
showing Southgate station  
as an integrated public realm,  
retail and transport hub

02  
SOUTHGATE  
As existing



**London is a growing city and the Underground network must expand, evolve and become more flexible to accommodate and support this growth. To achieve this, we must shift our traditional ideas of ownership and management boundaries, work together to challenge the theory that a station ends at the Bostwick gates, and engage with communities to embed stations in their place.**

### **Important things from this chapter to remember:**

- Stations should reflect their local character and history
- Station environments should connect to their outside spaces
- The quality of a station's public realm is important, as it is the first and last impression
- Maximise street presence, especially when part of an over-site development
- Encourage retail opportunities that are appropriate to the locality







# 3.0

## Consider wholeness

Good design starts by considering the whole: the whole station (from platform to pavement); the whole of the project from engineering to surface finishing; the whole team.

It's about making sure the right people are engaged from the outset. Considering 'wholeness' means creating entire spaces with clear forms, which are clutter-free and legible for all users and requirements.



## In this section:

- Considering the whole station
- Looking at the big picture
- Involving the team
- Creating wholeness of space and form
- Accessibility
- Clutter-free legible spaces
- Clutter examples and solutions
- Commerce as part of the whole



## 3.1 Considering the whole station

Whether carrying out a small patch repair or a major station overhaul, any project should take account of the whole station and its position within the network. Before starting any project, understand:

- How this piece of work relates to the rest of the station
- How the station's other spaces are likely to change in future
- The heritage and history of the station
- Any special features or important architectural details
- Which flashcard you need to use

← See chapter 6.0 for further information

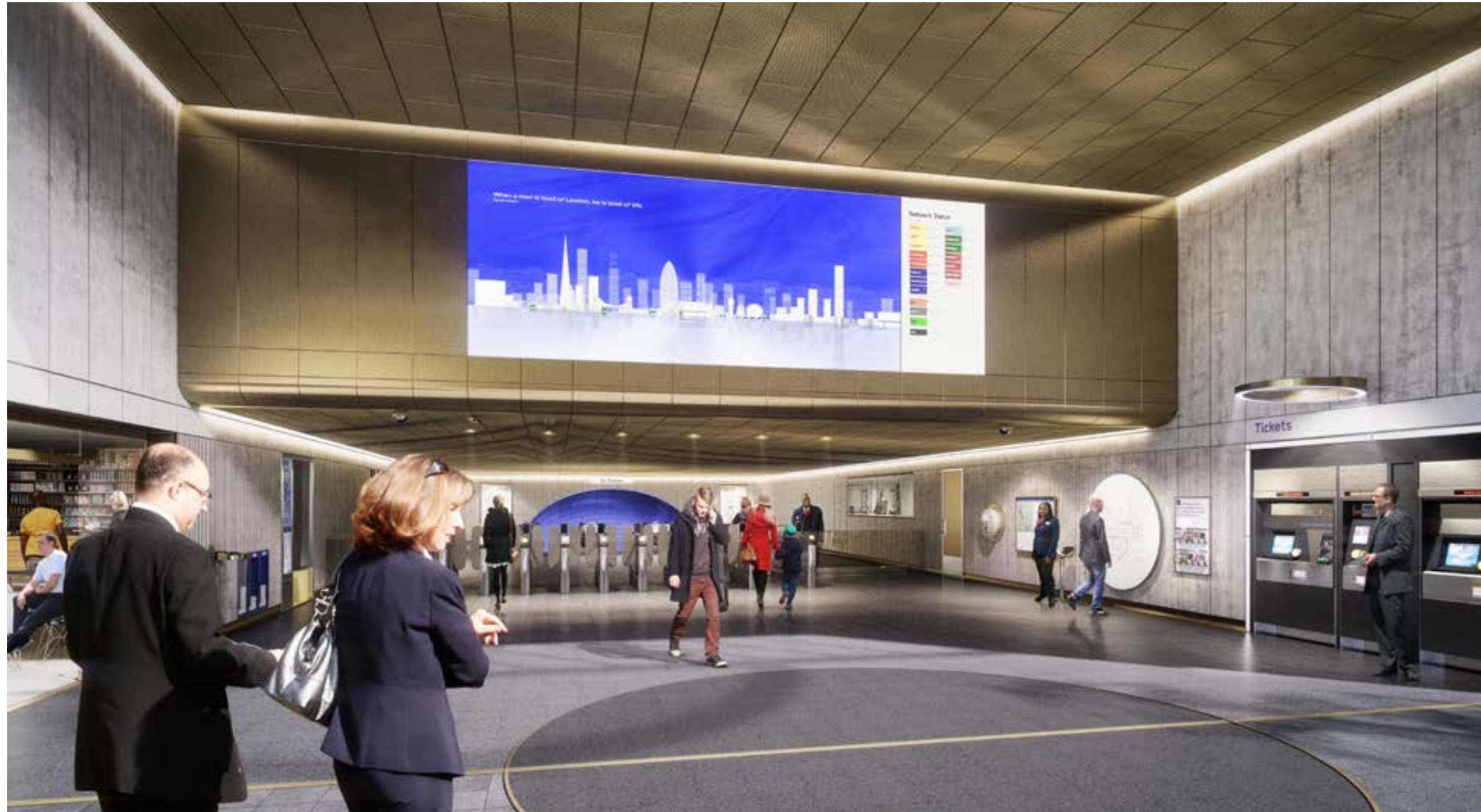

01  
TICKET HALL  
An artist's impression  
of a 2015 palette  
ticket hall

## 3.2 Looking at the big picture

There are many examples of Underground projects delivered in a piecemeal fashion, where layer upon layer of different measures build up to make an unsatisfactory whole. While each idea might have its merits, the overall composition needs to be considered.

- Combine different work streams into one programme
- Think about materials with their lighting and how they interact
- Consider customer information areas with retail and advertising
- Ensure way-finding and safety signage are not afterthoughts
- Integrate products and services from the outset

It is not always possible to combine all works together. But the important thing is to have an understanding of what will be designed, so that even when smaller works are carried out, they are well-integrated and complementary to the entire environment.

← See chapter 8.0 for further information





### 3.3 Involving the team

**Most projects on the Underground require the input of many people, with different sets of skills and responsibilities.**

At the start of a project, seek the advice of everybody involved to ensure any opportunities or issues can be addressed early on.

- Aim to deliver maximum customer benefit in the most cost effective way
- Understand the project's scope and delivery routes
- Understand the customer information needs
- Look for opportunities to enhance accessibility
- Ask the advice of the engineers
- Speak to the retail team
- Speak to the heritage advisers and urban designers
- Consult the wayfinding team

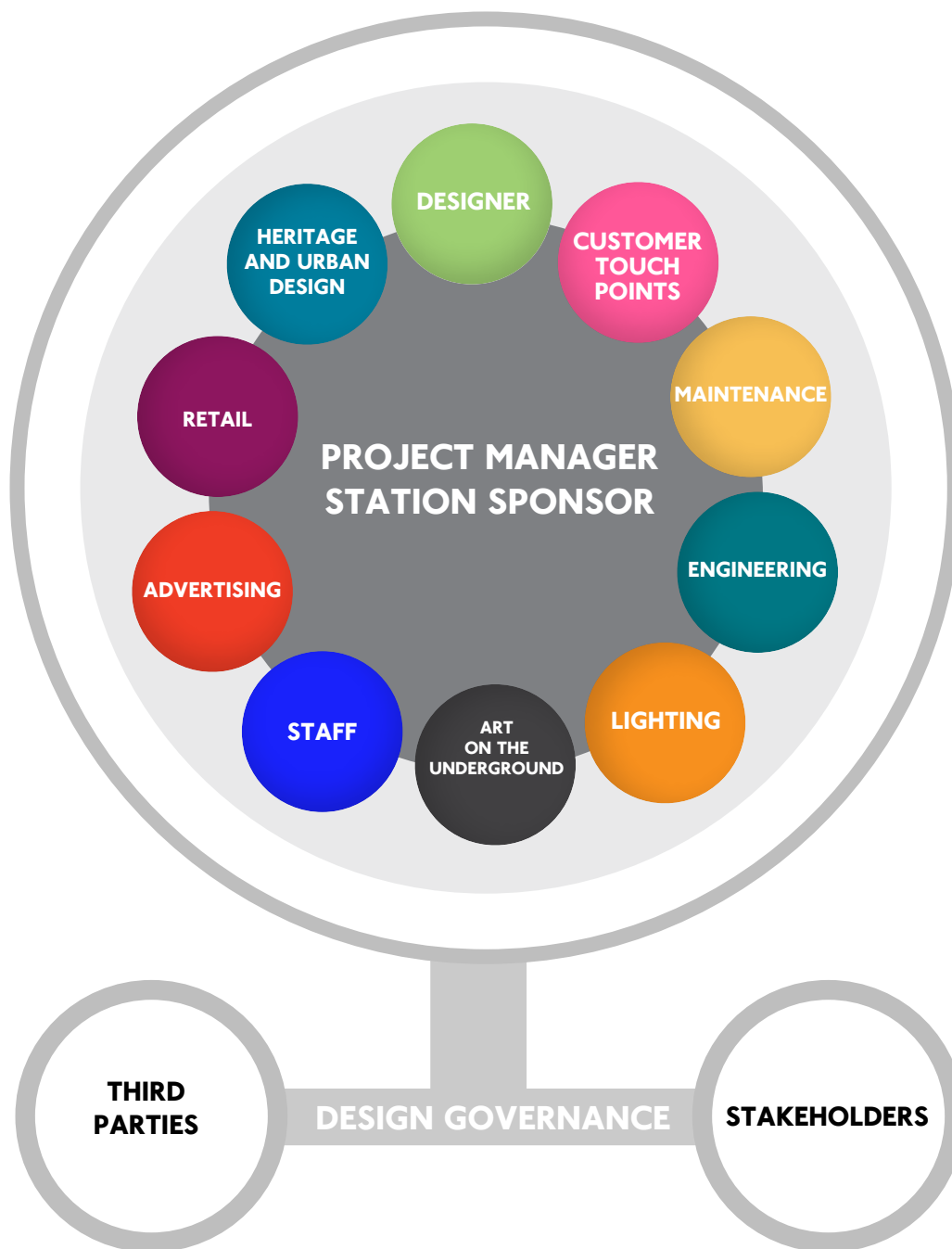

## 3.4 Creating wholeness of space and form



**A station should feel like one connected set of spaces from platform to pavement.**

This means:

- Using a harmonious colour and material palette throughout the station with a consistent lighting approach
- When working on existing stations, ensure at least one contextual design theme is carried through from the old to the new
- Spaces should be readable as whole geometric forms where possible
- The space should not be interrupted by additional structures or temporary elements
- Remove any unnecessary or detracting components
- Using a consistent lighting approach

By carrying an architectural element or motif through the entire station, immovable or disparate architectural forms can be linked into a more coherent whole. Such as continuing a color and material palette around odd geometric forms, or keeping the floor finish consistent throughout the station.

01





### London Underground aspires to be accessible to all users

Our customers have a wide range of requirements: they may have a disability, be travelling with luggage or a pushchair, and will be of all ages. Accessibility should be an integral part of the design process; a station which is accessible to customers with particular needs is easy to use for everyone.

01  
Tactile paving allows blind and visually impaired customers to identify specific areas

### Designing for accessibility

When designing a station, accessibility requirements should be integrated from the beginning, not added as an afterthought. For example, manifestations on columns or glazed areas should match the station flashcard palette, as should skirtings, stair nosings and other areas where contrast is required. If the station has long walking routes, consider providing seating if there is space.

➡ Elements within stations should follow the guidelines for accessible design laid out in BS8300

02  
Consider step-free access between the train and the platform



### Step-free access

When providing step-free access within a station, consider:

- Where step-free entrances to the station will be located and how they will be visible from the street. Where possible, they should be within the main entrance to the station
- What the step-free route through the station will be; make this as similar as possible to other routes to make wayfinding easier
- Try to keep the step-free route as short as possible. Sometimes customers who would prefer to use lifts are those who are least able to manage walking longer distances
- Consider what type of step-free access is most appropriate. As well as traditional lifts, it might be possible to use ramps, or inclined lifts. Within existing stations, make sure the design of the lift is appropriate to its surroundings
- Don't forget to consider step-free access between the platform and the train





## Accessible wayfinding

Lighting can play an important part in helping customers to navigate their way through stations. Lighting cues can be especially useful for customers who may find it more difficult to use signage. Use light to highlight key areas of the station and the main travel routes.

➔ See chapter 7.0 for further information

It is also important to carefully consider the signage within a station, to ensure that it is located where it can easily be viewed by all users. Avoid placing

signage high up in the ceiling and ensure that where there are different routes through stations these are clearly indicated. Ensure that tactile paving at the top and bottom of staircases and on platforms is in place to allow these areas to be identified by blind and visually impaired customers.

Consider the use of technology to improve accessibility. For example, in 2015 a system was trialled at Pimlico using Bluetooth beacons and an app to provide audible information to assist blind and visually impaired customers to navigate the station.

01  
London Underground customers have a wide range of accessibility needs



## 3.6 Clutter-free legible spaces

### Customers' judgments about the quality of their journeys begin before they enter the station.

Well cared for spaces make customers feel more comfortable. Clutter can greatly inhibit a customer's focus and undermine the clarity of the station, and this can affect the quality of the entire journey and their perceptions of journey time.

### Identifying clutter

'Clutter' is the unwanted layer of elements within the station, often accumulated over time, which can distract customers from reading key information and signs, thus reducing comfort and adding to stress. Clutter is any non-essential item in the station which does not emphasise the station's distinctiveness or add to a customer's safety, sense of order, or comfort.

Examples of clutter include:

- Ad hoc, unclear and improvised signage or flow control
- 'Make-do' solutions to 'fix' a problem, such as a bucket placed under a leak, or temporary passenger information posters stuck with sticky tape to paintwork (which then blisters on removal)
- Temporary equipment not tidied away
- Repeated customer messages in close proximity
- Incoherent signs
- Lots of similar safety information stickers clustered together
- Untidy spaces
- Portable white boards arranged in the wrong places



## When designing or revisiting a space, you should:

### 1. Take stock

Examine all the elements within a space and take note of each item and its purpose (or lack of purpose).

### 2. Ask if it's needed

Question if each item is really needed. Could the same information be conveyed in a clearer fashion? Does it cause confusion, or get in the way of key desire lines or lines of sight? Ask if it adds to the 'wholeness' of that space or whether it's impeding it.

### 3. Remove it

Remove all unnecessary components. If removing safety information or customer messages, ensure the correct procedure has been followed.

### 4. Consolidate

The simple act of clustering like elements often helps to make the environment feel more coherent. Use zoning to define areas where customer information, commercial opportunities and safety equipment can be found.

### 5. Keeping it clutter-free

Once an area has been decluttered, processes must be in place to ensure clutter does not accumulate again. This applies to general station spaces and other station tenants, such as retailers. The whole station should be managed holistically and proactively.





## Remember the 5 steps

Remember the five steps to help organise and sustain an efficient environment:



**Sort** – Declutter and remove unwanted or unnecessary items.

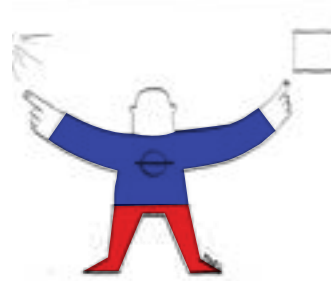

**Set** – Define appropriate locations for remaining items.

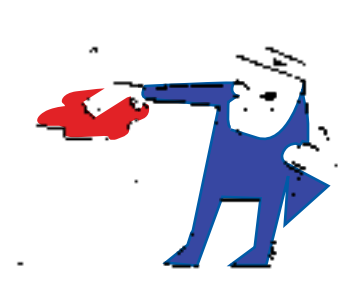

**Shine** – Introduce processes to keep the environment clean, tidy and easy to maintain.



**Standardise** – Use visual management techniques to define the structure for the area and make it easy to understand.

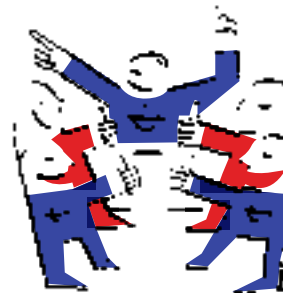

**Sustain** – Introduce processes to review, audit and challenge the previous steps.

## Design out crime

As a public authority TfL has an obligation to 'design crime out' under the provisions of the Crime and Disorder Act, 1998, Section 17.

So, when looking at a station design try to avoid the 'big things' such as unnecessary spaces behind structural elements (columns, etc) as well as 'small spaces' (such as voids behind equipment, cladding, etc).

External security features such as barriers are often later additions that create the very clutter we need to design out. Although such mitigating factors are necessary, look to deliver such features by intelligent design – planters, street furniture – while remembering that sometimes vehicle access to station entrances (for maintenance) is required.

Litter traps, pigeons roosting, 'hidden places' and the often required antidotes to these problems are the things that frequently create an equally poor image of a space. They should be designed out from the start, for instance, ledges and equipment 'tops' should be sloped or designed to take wire-systems not pigeon spikes.

## The benefits

When a station is free of clutter, customers feel safer and more comfortable, as it shows that the network is running well and spaces are cared for.

Clutter (noise, digital, physical objects) can strongly inhibit focused attention:

- Researchers at Princeton University Research Unit found that when your environment is cluttered, the chaos restricts your ability to focus and process information. It can also lead to stress as you struggle to concentrate
- Evidence from cognitive psychology shows that when stressed, our attention narrows and becomes hyper-vigilant to threat; in this state, customers develop 'blind-spots' and are unable to appreciate the built environment
- A customer who is in a stressed state because they cannot find their way through the station due to the amount of clutter, will be 'hyper-focused' on wayfinding and unable to enjoy the artwork on display

- A lack of order signifies a 'wild' space that is not fit for customers
- Spaces that have no clarity of direction and lack logic leave customers feeling confused and frustrated and increase a sense of overcrowding
- Cluttered, dirty, damaged and ad-hoc spaces show no sense of overall design standard and make customers feel that is not 'their space'

A network which is consistently free of clutter makes customers feel more positive about their journeys and the network.

This strengthens the Underground brand in terms of both recognition and higher customer and staff satisfaction.



## 3.7 Clutter examples and solutions



### Problem: Cables

Multiple, disparate and hanging cables and cable management systems which stand out.



### Problem: Duplicate signs

Multiple and duplicated signs or stickers.



### Problem: Ill-placed furniture

Redundant or ill-placed furniture or equipment.



### Problem: Railings

Multiple layers of redundant railings.



### Solution

Chase in cables or combine and conceal them within a cable management system which is well designed, either to match its background material and colour or designed as a feature.



### Solution

Reduce the number, don't duplicate information and combine into one single, ordered location.



### Solution

Remove furniture or equipment which is not needed, zone remaining furniture into complementary spaces and store back of house.



### Solution

Railings are not needed and should be removed unless their use is justified. Or use a concealed built-in socket post system.





### **Problem: Mobile equipment**

Mobile equipment that is unused or not stored properly.



### **Problem: Bad patch repair and pest control**

Poorly completed patch repairs or exposed pigeon spikes and wire.



### **Problem: Cluttered street presence**

An overload of signage with no hierarchy or space to breathe.



### **Problem: Too much customer information and advertising**

Advertising and customer information clustered together with no sense of order.



### **Solution**

If it's not being used, store it in a back of house area.



### **Solution**

Repairs must be a complete visual match. Any pest control must be considered and discreet.



### **Solution**

Remove redundant and duplicated signage and equipment to restore balance and create an inviting 'welcome'.



### **Solution**

Less is more! Use less, higher impact advertising and zoned information to create impact spaces.

## 3.8 Commerce as part of the whole

**All commercial activities within the station should contribute to the station's feeling of 'wholeness'.**

This can be achieved through:

- Matching retail materials and trims to those of the Design Idiom palette and flashcards
- Ensuring that tenant lighting does not compete with the lighting of the station
- Choosing retailers which are appropriate to the station and its setting
- Ensuring retail signs do not dominate the station



← See The Retail Design Guide (2015) for further information



01  
HAMMERSMITH  
A new retail unit within  
an historic station

02  
MORDEN  
A local newsagent integrated  
into the ticket hall

03  
CANARY WHARF RETAIL  
Glass frontage retail units with  
ambient lighting to complement  
the decluttered station it sits in





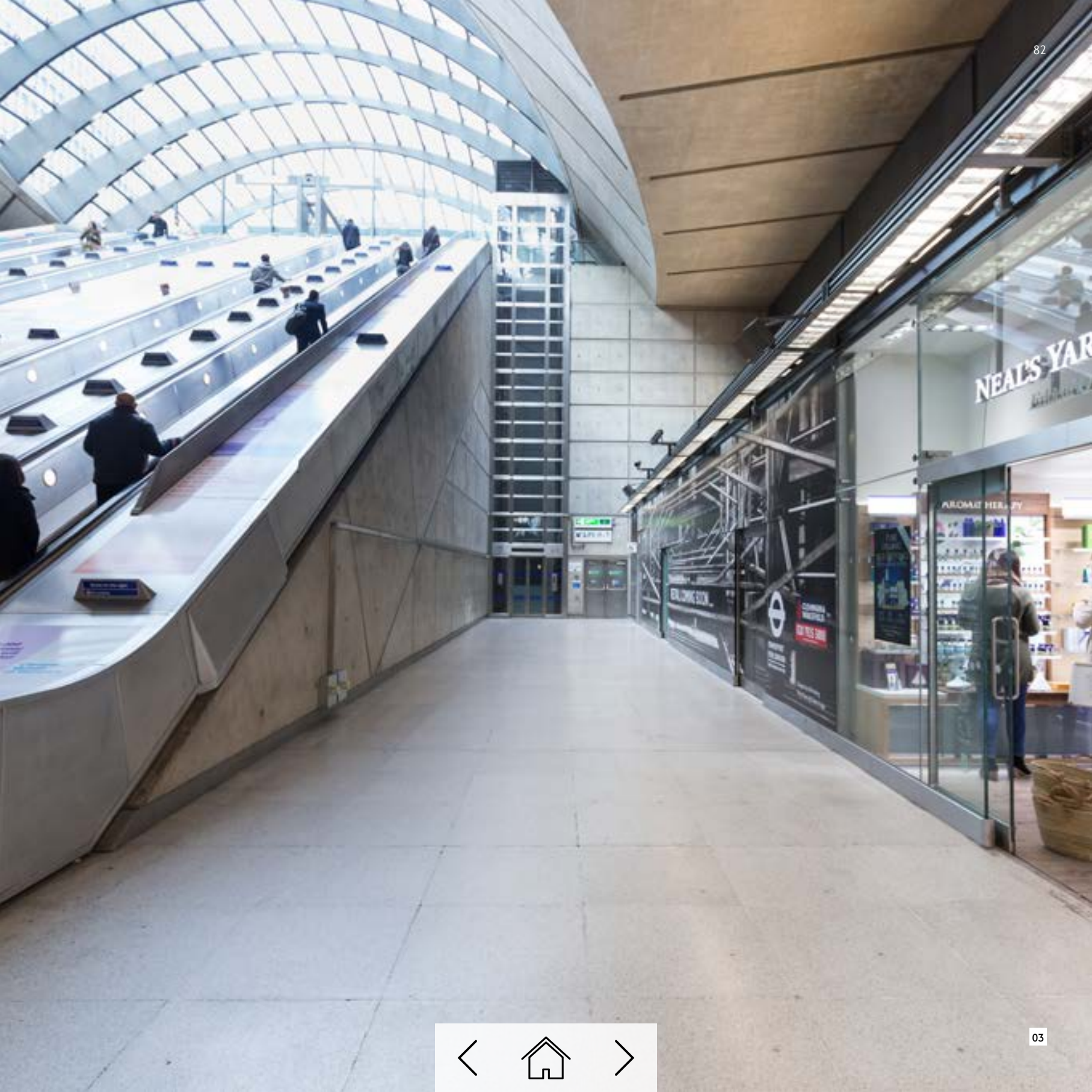





ROUTEWAY  
Artist's impression  
showing an  
immersive and  
decluttered space



**Often station interventions are designed and implemented in isolation, but this can have negative knock-on impacts to the broader environment. When designing new stations or altering existing ones, create whole spaces, involve the whole team, and keep stations free from clutter.**

**Important things from this chapter to remember:**

- A single intervention can impact the whole station
- Combine multiple station interventions
- Remember to design whole spaces
- Involve all disciplines from the beginning
- Ensure stations are free from clutter







# 4.0

## Prioritise comfort for staff and customers

Well-designed stations support staff in their varied roles so they can provide world class customer service.

It is this interaction between staff, customers and the built environment that makes London Underground stations so special and distinguishes us from other metros.



## In this section:

- Building a network around people
- Ownership of station spaces
- Designing ticket halls from a staff perspective
- Staff accommodation and back of house
- Technology know-how
- New uniform



## 4.1 Building a network around people

**People should be at the heart of all decision-making, with the simple aims of making places more comfortable and easier to use.**

Station staff are the face of the Underground. Direct contact with staff members who are easy to spot, approachable and knowledgeable is a significant part of the Underground's customer offer. Ticket halls are the main area where staff interact with customers, whether this is helping them to buy a ticket, advising them on the best way to make a journey or providing information about the local area. While technology lets customers take ownership of more elements of their journey, this kind of direct interaction with staff is still needed, especially for those less familiar with the network.

Station staff are responsible for the operation of the station and ensuring that customers can move safely through it, even at the busiest times. They have a varied and sometimes challenging role which must be taken into account when designing the spaces they work in.

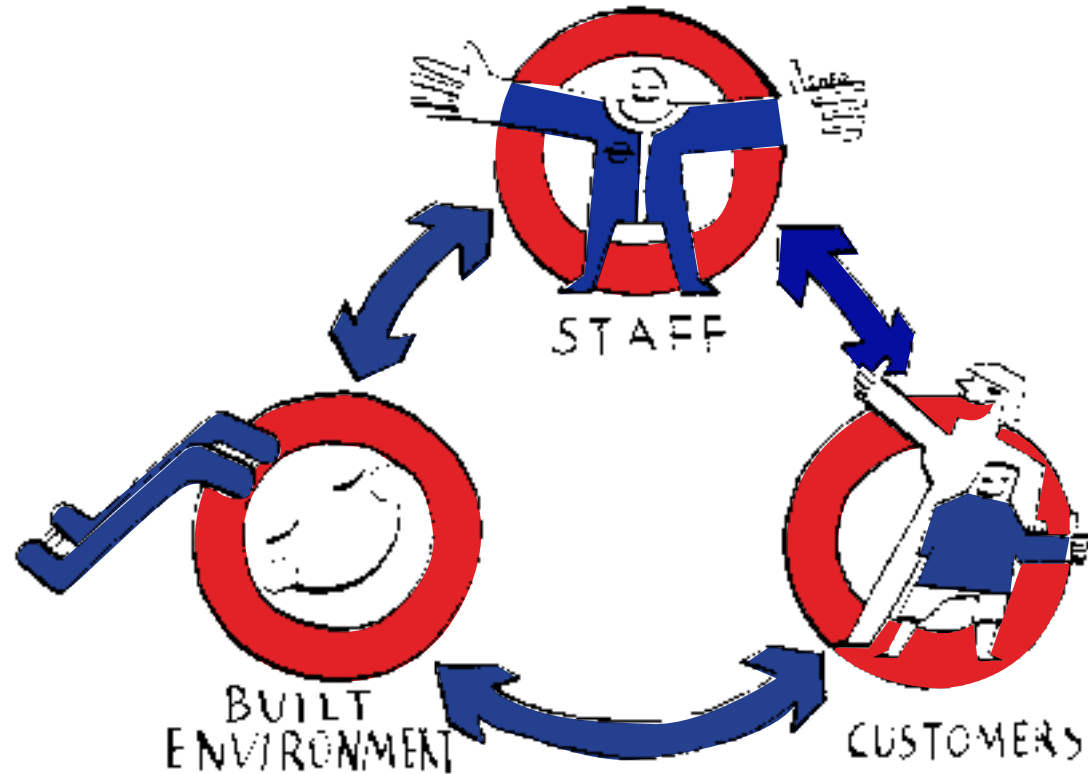



## 4.2 Ownership of station spaces



01

**Stations have a wide range of users with varying needs and expectations. Good design enables staff to meet those needs.**

The location of Underground stations range from the busy locations in the Capital's centre, where many customers may never have travelled on the Tube before, to quieter stations in the suburbs or outside London, through which many customers travel daily.

Each station has its own specific customer requirements. However, station staff have vast knowledge of their station's users and understand the local community. They should be involved in the design process where possible to share this knowledge of who their customers are and how they use the station, and to maximise opportunities to promote local character and history within the station.

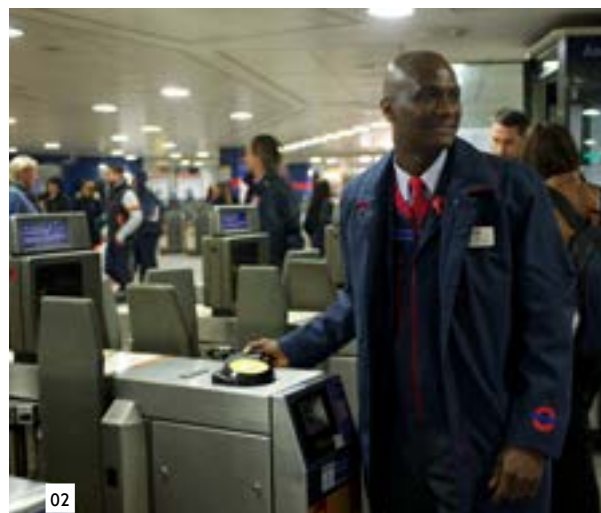

02

## 4.3 Designing ticket halls from a staff perspective

### The ticket hall sets the expectation for our customers' journey. For many, it is their first experience of London.

The ticket hall has a range of uses, many of which are non-travel related (including London visitor information, local advice, retail, other commercial services and advertising). When placing these additional services, the objectives of allowing customers to enter and exit easily and of enabling staff to provide customer service must remain paramount.

Design the ticket hall to support staff in providing great customer service by allowing them to be easily seen and more accessible to customers. In the past, staff have often been located in ticket offices where they were visible but less approachable. Having staff in the ticket hall means they are more attainable and can provide the support customers need.

While staff may be dotted around the ticket hall, each station should have a clearly defined customer information zone which provides a focal point for people who need help. This should be easily visible to customers entering the station and placed where staff can talk to them without obstructing others.

Depending on the type of station, this area can be:

- A Visitor Information Centre, which can provide a wide range of information about travelling in London, plus more general tourist information
- A customer reception, which provides a space outside of the main station routes where customers can approach staff
- A dedicated information zone, indicated with an 'i' sign or white circle where staff can help with journey planning or ticket enquiries and have access to leaflets
- When staff are not located by the information zone, there should be a clearly identifiable 'station office' where customers can find a member of staff if they need assistance

Other design features which help staff interact more easily with customers include:

- Grouping customer information logically to allow staff to help customers within specific areas, rather than needing to move around the space
- Providing a clear, clutter-free environment so staff have a clear view of customers and can reach those who need assistance
- Providing staff with a mobile device to help provide information
- Providing an open space without blind spots or dark corners which has a place of safety for staff



01, 02  
STAFF ASSISTING  
CUSTOMERS  
Interacting with their  
local communities



## 4.4 Staff accommodation and back of house



01

### Primary staff suite

Good design is equally important in staff areas of the station. Part of enabling staff to provide great customer service is ensuring they have appropriate areas to carry out administrative tasks and to relax during break times. Each station will have a primary suite of accommodation which should contain:

- A welcoming staff front door
- A station office which can be used for a variety of functions, including training and performance management
- Mess facilities to rest with other station workers
- Lockers for each staff member
- Toilets

The primary suite should be well lit and well ventilated. As a minimum, the station office should be at ticket hall level to maximise natural light and staff visibility. It should be obvious to customers where the station office is if they cannot find a member of staff elsewhere in the station.

Place station control rooms at ticket hall level and have large windows on to the ticket hall so customers know that the station is being actively managed and monitored.



02

01  
A STAFF MEMBER  
CHANGING A  
POSTER

01  
BAYSWATER  
Underground in Bloom

### Secure suite

Currently, ticket machines are housed within a secure suite. The secure suite supports:

- Refloating of ticket machines
- Secure storage of cash
- Cash counting and accounting activities
- Storage of ticketing consumables

In stations with space constraints, cash machines can also be housed in the secure suite.

Enough space must be made available for these items and other essential activities must be considered. These suites also need to be secure enough to protect the cash levels on site and the staff members working within the suite.

In the future the Underground is considering the use of front loading ticket machines which will allow ticket hall spaces to be opened up further.

### Back of house space

All stations need back of house spaces. These include equipment rooms for lifts, escalators and communications equipment. When designing these spaces, consider who needs to access them and for what. Arrange back of house areas in a logical way and provide enough space for required activities to be carried out efficiently.

If station equipment needs to be installed in customer-facing areas of the stations, ensure this is done in an unobtrusive way that does not impede customer movement or staff views of the ticket hall area. Where possible, make it appear integral to the station so it is barely noticed by customers and cannot be easily tampered with.

When staff are not located by the information zone, there should be a clearly identified 'station office' where customers can find a member of staff if they require assistance.





## 4.5 Technology know-how

### Technology offers London Underground a range of opportunities to interact with its customers and make their travelling experience easier.

It can also allow staff to provide more effective assistance to customers.

Staff increasingly have access to mobile technology to allow them to provide customers with more accurate information on the spot. For this to be an effective tool, staff need to:

- Be aware of the online services offered and how to use these to support customers with their journey needs
- Have a good knowledge of available mobile technology and be confident in using this
- Know when technology can best be used to address a customer issue and when other types of assistance may be better
- Be aware of what technologies the organisation will implement in the near future

When designing ticket halls, future technology should be considered and, where possible, provision made to accommodate this (eg, when deciding where to put power points and the capacity of the station's electrical and cable management systems).

Remember that while technology can perform a range of functions, for many customers, face-to-face contact with staff will continue to be essential to reassure them while travelling across the network.

➔ See chapter 9.0 for further information

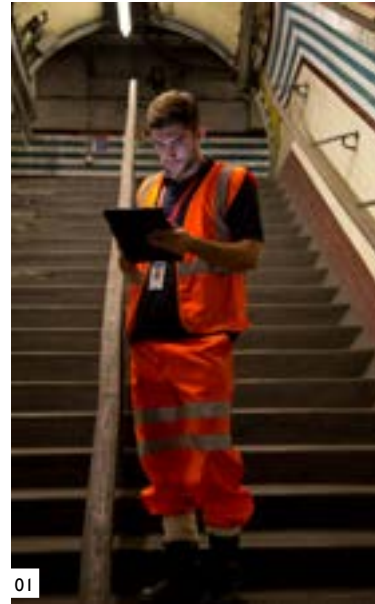

01

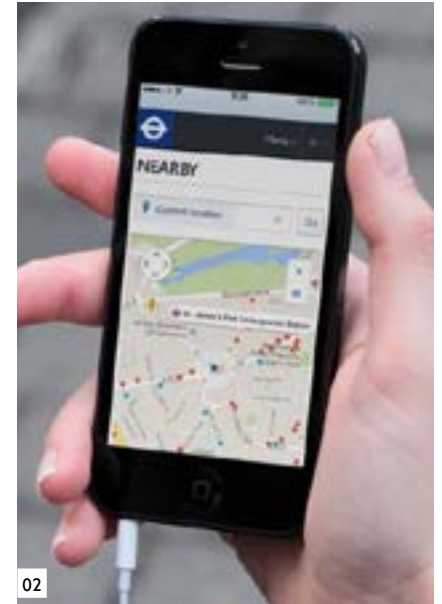

02





## 4.6 New uniform

**The appearance of staff contributes to the overall impression of the station and illustrates the professionalism of London Underground's people.**

The staff uniform complements the ticket hall design by making it easy for customers to identify members of staff in what can be a very crowded space. In 2015, a new uniform was launched that:

- Used the roundel and the Underground red and blue to allow staff to be clearly identified
- Considered the size and shape of pockets to enable staff to carry essential equipment, such as mobile devices, radios and pens
- Provided a range of different items of clothing to accommodate the personal preferences of individual members of staff and that some may be based outdoors or at warmer locations than others



01



02

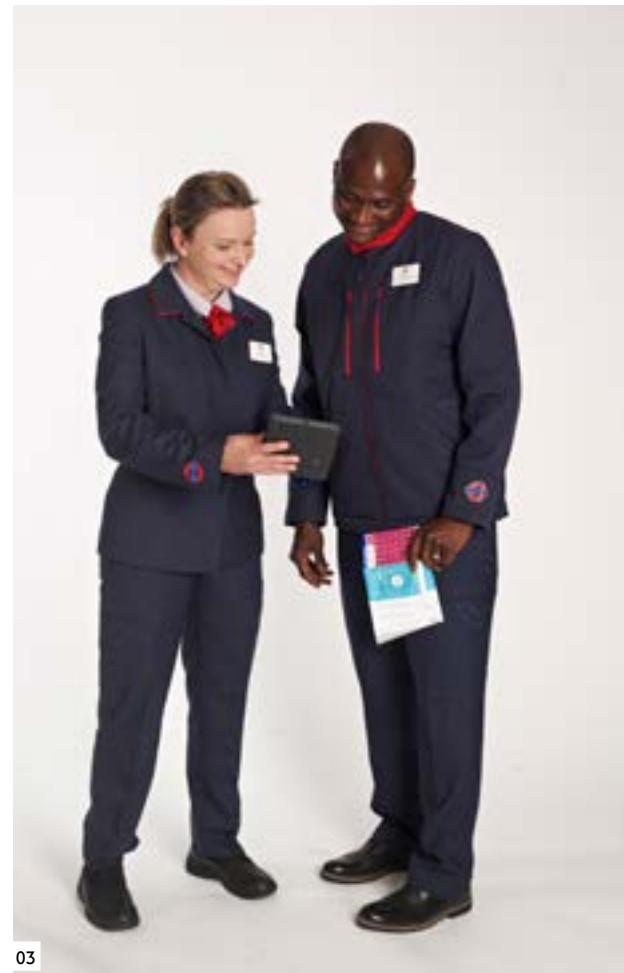

03





**Stations are not just for customers, they are for staff too. Our people are the lifeblood that ensures the smooth and efficient delivery of the service day after day. Consider all design from both a customer and staff perspective. Remember to design stations for people.**

**Important things from this chapter to remember:**

- Design stations for people
- Design ticket halls from a staff perspective
- The key components of primary and secure suites
- How important technology is as an enabler of enhanced customer service





# 5.0

## Delight and surprise

Every Underground station should include at least one moment of delight and surprise, to improve customers' journeys and the working environment for staff. Such moments help put the network on the map, as a world-class leader of design.





## In this section:

- Recognising what's special
- Celebrating heritage
- Promoting a sense of nature
- Creating multi-sensory experiences
- Designing special lighting
- Engaging with culture and Art on the Underground
- Creating impact with advertising



# 5.1 Recognising what's special

## Many of the Underground's stations are already great!

Recognise what makes a station special and enhance and preserve those features. Special architectural quality and generosity of height and space already help to define many Underground stations, so create this generosity where possible.

While the Design Idiom aims to create a level of consistency across the Underground network, it is also essential to recognise the idiosyncratic nature of the system and the importance of stations being individual.

Reinforce and enhance a passenger and staff pride in the stations they use by identifying the features that contribute towards a sense of distinctiveness.

This includes:

- Heritage
- Unique artworks
- Local area history
- Specific area identity and features
- The Art on the Underground programme
- Links to local institutions or culture
- Thought-provoking architecture



01

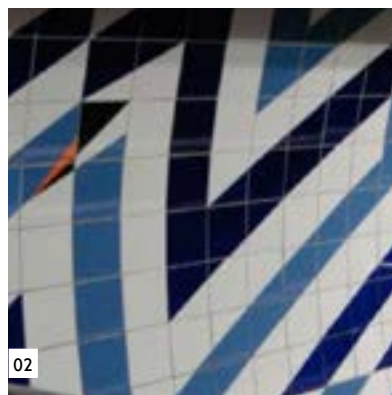

02



03



04

01  
NORTH GREENWICH  
'Hanging' platforms, raking columns and immersive colour make Will Alsop's North Greenwich station memorable

02-04  
VICTORIA LINE  
Platform seat back tiles at Stockwell, Euston and Oxford Circus reflect the local area





01



02



03



04



05



06

### The Underground has a great heritage of design, which runs through the architecture, station design and graphic design.

This rich heritage and the history of great design and craft should be celebrated and highlighted. New design must stand up to this heritage too.

- Understand a station's heritage features to strengthen its design rationale
- Reveal and restore heritage features in their existing locations where possible

- If a heritage feature has to be moved, ensure it is reinstated somewhere prominent
- Use lighting to highlight heritage features
- Ensure any changes, including new poster or advertising frames and commercial elements, fit in with the existing heritage features.

➔ See LU Standard I-355 listed buildings and other structures of design of historical importance

➔ See LU Railway Heritage Features, and Good Practice Guide: Managing Underground Heritage

Showcase cabinets and displays can help celebrate the wealth of heritage material a station has to offer. These could take the form of posters, artefacts, images, stories or preserved architectural elements.

01  
ARNOS GROVE  
Ticket hall today

02  
SOUTHGATE STATION  
Escalator space

03  
LESLIE GREEN  
Green heritage tiles

04  
RUSSELL SQUARE  
Oxblood facade

05  
GLOUCESTER ROAD  
Heritage tiled signage

06  
MAIDA VALE  
Decorative  
mosaic roundel





## 5.3 Promoting a sense of nature

**Bringing a sense of nature into stations creates a connection to the outside world and makes stations feel more open.**

To bring a sense of nature into a station you should:



01



02



03

### Enhance natural light

Introduce as much natural light as possible. Maximise and add glazing, raise ceiling heights and create light wells and sky lights to bring light deep into the station.

### Or mimic it

Suggest a connection to the natural world using artificial light. Soft shafts of light from above, with a similar colour temperature to sunlight (or moonlight), can mimic the effects of natural light.

### Add greenery

Connect customers and staff to nature by adding greenery. The Underground in Bloom competition is a great example of this, but does not run all year. Use green walls to brighten up otherwise dead façades.

01  
BLACKFRIARS  
The glazed facade floods the ticket hall with light

02  
WESTMINISTER  
Lighting was originally used to enhance the structure, it also succeeds in mimicking ambient natural light

03  
EDGWARE ROAD  
An otherwise dead façade is transformed using a green wall

04  
SOUTHWARK  
Ticket hall space uses light bounced from the soffit fittings

05  
BIRDSONG  
The right natural sounds can create interesting soundscapes to stations

06  
CAST CONCRETE  
Shells cast into concrete at Green Park station

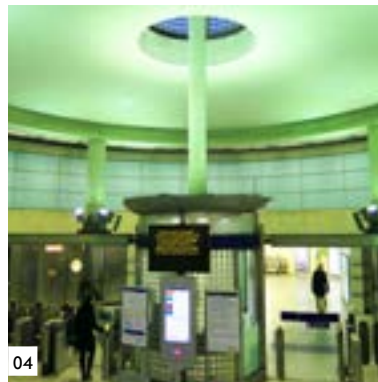

04



05



06

### Reflect changes in night and day or seasons

Use different light effects to reflect conditions outside the stations. Changing the colour 'temperature' of the lighting depending on the time of the day can achieve this.

### Introduce natural sounds

Use sounds of birdsong, gentle breezes or water flowing to link the station to its environment – is it close to an underground water source, a park or woods?

### Use nature to inform material choice

Casting leaves, shells, patterns of water, pebbles/stones or tree patterns into materials such as concrete add a sense of nature.



## 5.4 Creating multi-sensory experiences



Travelling on the Underground is a sensory experience, punctuated by: the sounds of trains, announcements and chatter; the sense of changing temperatures between spaces; the feeling of different textured surfaces; and a variety of different smells. We know from recent research that engaging customers on a multi-sensory level can have positive impacts on both overall satisfaction and reputation.

- Consider engaging all the senses
- Consider how the senses work together
- Enhance mood through music
- Add pleasant smells through planting
- Use tactile materials
- Create light and sound installations



Remember that a large amount of the network is overground, with a different set of sensory experience on offer.

01  
U-BAHN WESTFRIEDHOF,  
MUNICH, GERMANY  
Using light to create  
multi-sensory experience

02  
RADHUSET METRO STATION  
Radhuset in Stockholm uses organic  
architecture, which leaves the  
bedrock exposed and unsculptured,  
appearing to be based on  
natural cave systems





## 5.5 Designing special lighting

### Use lighting to create inspiring environments and improve the relationship between architecture, space and people.

- Embrace lighting as part of the architecture
- Create exciting destinations with contrast, drama and colour
- Provide a comfortable, low glare environment
- Highlight specific station areas and features
- Ensure any changes do not compromise safety, accessibility or maintainability

Feature lighting – be it feature chandeliers or concealed, coloured illumination – provides an extra layer of interest.

➔ See chapter 7.0 for further information



01



02



03



04

01  
GLOUCESTER ROAD  
Replica heritage lighting on  
the District line platforms

02  
HAFENCITY  
UNIVERSITY STATION,  
HAMBURG, GERMANY  
Light boxes are the same size as  
a standard shipping container,  
as if mimicking the subway  
trains themselves

03  
BOCHUMER  
VEREIN, BOCHUM  
The walls change their colours  
intelligently. Normally blue, they  
turn red when a train approaches,  
and white while a train is  
in the station

04  
MANOR HOUSE  
A striking ceiling design  
with feature lighting





## 5.6 Engaging with culture and Art on the Underground



01

**The Underground has a wealth of art and cultural programmes which can transform the ambience of a station, improve people's impression of the Tube and contribute to the design legacy of the network.**

- Embrace Art on the Underground in live, temporary or permanent programmes
- Find space for the busking programme
- Promote 'Poems on the Underground'
- Engage local cultural institutions
- Improve staff involvement, ownership and pride in local environments
- Create environments and experiences that delight customers and affirm the place of a station within the community

Art on the Underground can make a huge contribution to new stations and major upgrades in order to create new and special moments of individuality for stations in the future. There are a number of ways to make special moments when major changes are planned to stations:

- Consider incorporating a unique artwork early on in station designs or redesigns
- All artworks should be considered through the Art on the Underground programme
- Art on the Underground has the expertise to approach artists and support the development of initial ideas, through to artwork completion
- Artworks should be an integral element of the design of a station, rather than something added later; the earlier the discussions start, the better



02

01  
NOTTING HILL  
GATE STATION  
Harold Offeh and young  
people from Baraka Youth  
Association and Canalside  
Activity Centre Part of the  
Labyrinth engagement

02  
LIVE PERFORMANCE  
Performance by Ilona  
Sagar at Bermondsey  
station, part of Labyrinth  
event programme in  
collaboration with Art  
Licks, October 2013

## 5.7 Creating impact with advertising

**Impact advertising can be immersive, stimulating and thought-provoking. It can lighten the journey, while providing entertainment.**

- Impact advertising is best when specific to its space and fitting to the architecture
- It is even stronger when it is rooted to its neighbourhood
- Engage with commercial development to attract brands which make the Underground and its spaces more interesting, dynamic and stimulating
- Make it appropriate to its place (historic interiors do not suit all types of advertising)

Retail brings convenience to stations and, by using interesting brands and showcasing of devices such as pop-up shops, can look great and create excitement.



01



02



03

01  
OXFORD CIRCUS  
A single advertiser dominates the space to create impact. Photograph provided by Exterion

02  
SOUTHFIELDS  
Linking the station to the Wimbledon tournament to create an impact. Photograph provided by Exterion

03  
ESCALATOR CAMPAIGN  
Advertising that makes use of a specific space



**Each station must have at least one distinguishing feature, one special moment, which allows it to be memorable and engage with its immediate neighbourhood.**

**Important things from this chapter to remember:**

- ♦ Recognise what makes a station special in order to improve customer satisfaction and reputation
- ♦ Generate individuality and celebrate heritage
- ♦ Promote a sense of nature
- ♦ Create a multi-sensory experience
- ♦ Use tools like lighting and advertising to create impact and drama







# 6.0

## Use materials to create atmosphere

The quality of materials has a huge impact on the way a station is perceived by both customers and staff. High quality materials that are robust and easy to maintain make better environments.

Use materials to make atmospheric spaces that are dramatic and rich in texture.  
Make stations more memorable to customers and better places to travel to or through.



## In this section:

- London Underground's DNA
- Network station design type map
- Using the right flashcard
- The 2015 palette
- Applying the materials
- The 2015 palette applied
- Station exteriors
- Getting the detail right
- Modular systems
- Materials formats and setting out
- Floors and skirtings
- Ceilings
- Walls, columns, stairs and handrails
- New works in existing stations
- Craft
- Case study: applying materials to an existing station
  - St James's Park





## 6.1 London Underground's DNA

### **London and the Underground are synonymous. A well-functioning station will both signify and reflect the Capital.**

It is of vital importance to the economy and the pride of all who use the Underground that the network continues to provide world-class environments for both staff and customers.

The Underground is often characterised by the Tube map or the roundel, but, in reality, it is more than these elements. It is a living entity, brought to life through the craft and detail of its built environments, and the passion and professionalism of its people.

If you took away the roundel and station name, how would you know you were still in a London Underground station? You would know because of the idiosyncratic nature of the spaces, the attention to detail, the consistent use of quality materials, and the personalities of the people who make the system run so well each and every day.

The use of noble materials and strong colours, such as ox blood faience, polished concrete, and bronze, corporate blue and oxidised copper, have become synonymous with the Underground brand. They both reflect our history and provide guidance for the future. As you move through this chapter, you will be reminded of this, as well as the Underground's many examples of using well-crafted, beautifully detailed and high-quality materials.





**Glazed square tiles,  
regular bonded**



**Light stone detail**



**Cast ornate metalwork**

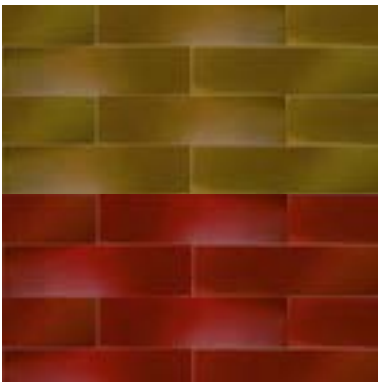

**Glazed tiles**



**Portland stone**



**Painted vertical tongue  
and groove panelling**



**Bottle green tiled  
dado band**

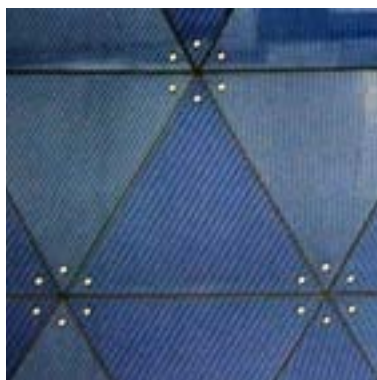

**Backpainted glass**



**Precast concrete panelling**



# 6.2 Network station design type map

The Underground's stations can be divided into a number of distinct categories that represent different station design types.

The station design types set common design elements such as colour and materials, plus unique and special features (such as timber handrail details or ornate metalwork). The network station design type map also tells you a station's heritage status, which must be understood before any works are considered.

Each station category has an associated flashcard which summarises the aforementioned features.

## Network station design type

- 10.01 ● Central London Railway
- 10.02 ● Clarke (City)
- 10.03 ● Clarke (Suburban)
- 10.04 ● District Victorian
- 10.05 ● Great Eastern
- 10.06 ● Great Northern
- 10.07 ● Great Western
- 10.08 ● Heaps (Early)
- 10.09 ● Heaps (Later)
- 10.10 ● Holden (Northern Style)
- 10.11 ○ Holden (Piccadilly Style)
- 10.12 ● JLE Style
- 10.13 ● Late 1970s
- 10.14 ● Leslie Green
- 10.15 ● London, Midland and Scottish Railway (Upminster)
- 10.16 ● Metropolitan Victorian
- 10.17 ● New Works (Pre WWII and Post WWII)
- 10.18 ● Victoria Line Style
- 10.19 ● Whitechapel and Bow, LTSR and LNWR
- 10.20 ● 2015 Palette
- ⊙ Network Rail

## Heritage

- Listed Structures
- Locally Listings
- Conservation Areas

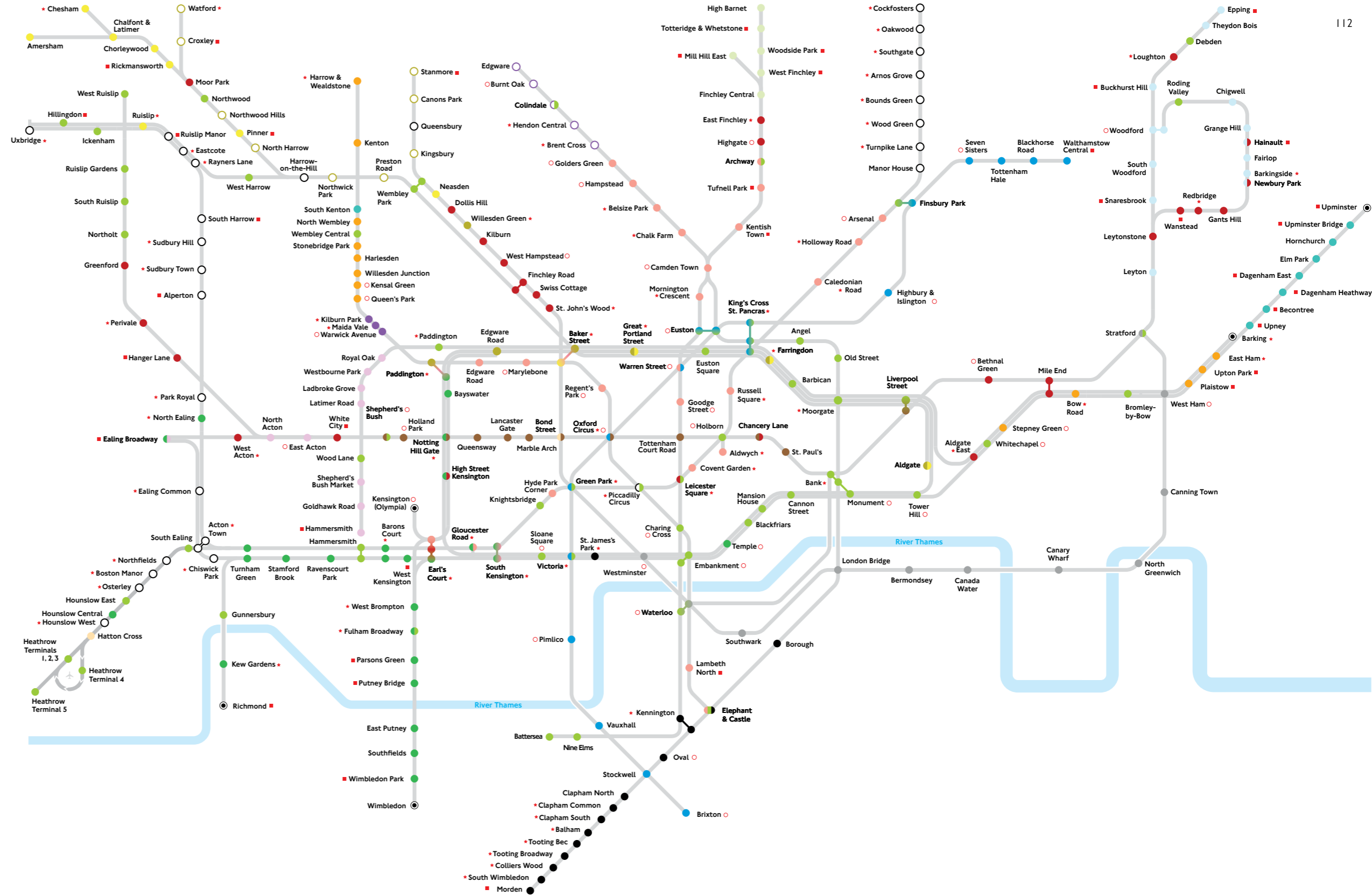



## 6.3 Using the right flashcard

**Each station type flashcard contains all the information required to undertake work at a station in an appropriate and sympathetic way.**

You can identify the correct flashcard for the station that you are working on using the network station design type map. Be aware that some stations may fall into more than one station type; make sure that you have identified the right one for the station area that you are working on.

The flashcards provide details on the predominant colours, architectural features and materiality of each station type. They also provide typical examples of each design type to help you to understand how the elements work together and to guide decision making.

➔ Find the Idiom flashcards in section 10.0

What you will see on each flashcard

### 10.01 Central London Railway

Central London Railway – Stations, originally designed by architect Harry Bell Measures. Only a few surface facade buildings survived but the plain white tiled platforms have been progressively reintroduced.

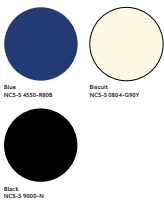
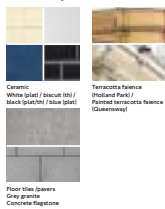
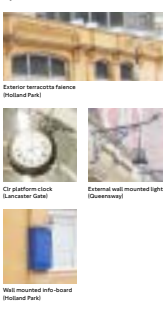
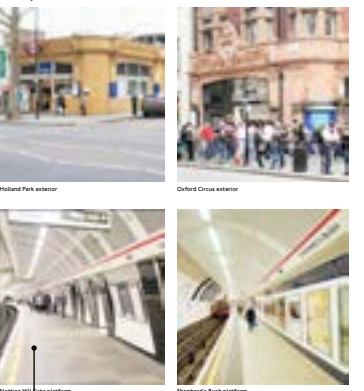
Stations	Colour	Materiality	Special features	Examples Stations
Bond Street ticket hall, roadways and Central line platform Chancery Lane Holland Park Lancaster Gate Liverpool Street (Central line platform) Marble Arch Notting Hill Gate Oxford Circus (including Victoria platform) Queensway Shepherd's Bush (platform) St. Paul's Tottenham Court Road (including mosaic)	 <p style="font-size: x-small;">Blue NCS-S 4550-8808</p> <p style="font-size: x-small;">Beige NCS-S 0804-G997</p> <p style="font-size: x-small;">Black NCS-S 1000-N</p> <p style="font-size: x-small;">Trim colour Bronze finished brushed stainless steel</p>	 <p style="font-size: x-small;">Ceramic White (light) / biscuit (top) / black (left) / blue (left)</p> <p style="font-size: x-small;">Terracotta facade (Holland Park) / Painted terracotta facade (Queensway)</p> <p style="font-size: x-small;">Floor tiles (jaspers) Grey granite Concrete flagstone</p>	 <p style="font-size: x-small;">Exterior terracotta facade (Holland Park)</p> <p style="font-size: x-small;">Clock platform clock (Lancaster Gate)</p> <p style="font-size: x-small;">External wall mounted light (Queensway)</p> <p style="font-size: x-small;">Wall mounted info board (Holland Park)</p>	 <p style="font-size: x-small;">Holland Park exterior</p> <p style="font-size: x-small;">Oxford Circus exterior</p> <p style="font-size: x-small;">Notting Hill Gate platform</p> <p style="font-size: x-small;">Shepherd's Bush platform</p>

This column shows the stations in this category

This column shows the overall colour palette

This column shows the most common materials

This column highlights the station's important features

These are images of stations that are the most typical of their design type



## 6.4 The 2015 palette

**The 2015 palette is next in the evolution of the design of the Underground. As such it is described in more detail than the other flashcards over the following pages.**

The materials and colour palette have been chosen with the design heritage of the Underground in mind, while being firmly rooted in the 21st century. They should be applied to all stations marked as '2015 palette' on the network station design type map.

Consider where elements of the 2015 palette can be used at stations which fall into other design types, whilst maintaining their individuality and

distinctive character. For instance, a bronze finish woven mesh ceiling might work at a 'Metropolitan Victorian' station. Appropriately extending elements of the 2015 palette to other station types will help reinforce a level of consistency and continuity across our network.

Overall the palette will create atmospheric, dramatic and sensual spaces. The materials and colour palette have been chosen for their textural, tonal and tactile qualities, and to work in tandem with their lighting. The palette has enough scope in material choice to allow for individual station identities to thrive while maintaining a strong identity across the network and to strengthen the Underground brand.

### Tips on using the palette:

- Atmospheric spaces are achieved through creating contrast in materials and lighting
- Contrast can be between light and dark, bright and dull, and rough and smooth
- Good lighting amplifies these contrasts
- Natural materials such as stones, marble or concrete have inherent texture and detail; they are 'tactile' materials, classy and pleasant to touch
- Combine textural materials with finer, shinier materials – such as tiles, glass and steel – to achieve a strong contrast
- Use colour to highlight key features and to differentiate spaces from one another

How to read the new palette

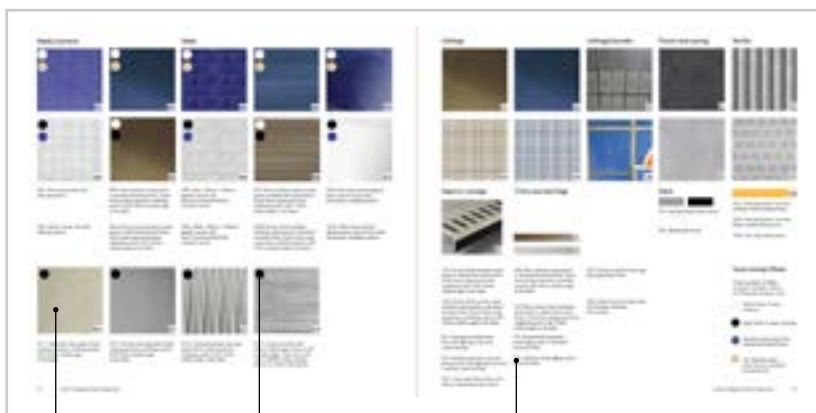

These columns show the materials to use for each surface

These dots show the contrast colour or material that can be used for each material

These are descriptions of the materials



## Walls/columns

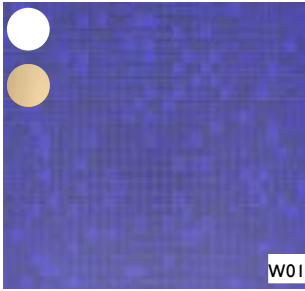

W01: Blue mosaic tile with dark grey grout.

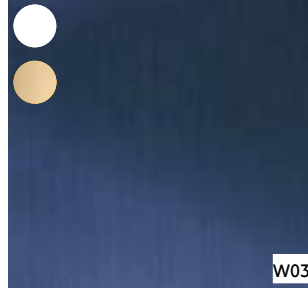

W03: Blue stainless steel panel in vibration/brushed finish. Panel fixed using proprietary cladding system with 20mm shadow gap to all sides.

## Walls

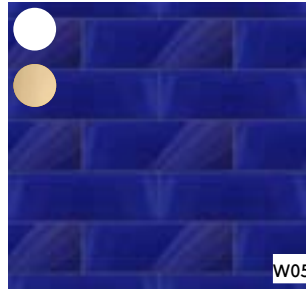

W05: Blue 100mm x 300mm glazed ceramic tile, laid in horizontal/vertical stretcher bond.



W07: Blue profiled stainless steel panel in vibration/brushed finish. Panel fixed using proprietary cladding system with 10mm shadow gap to all sides.



W09: Blue back painted glazed panel, secret fixed using proprietary cladding system.

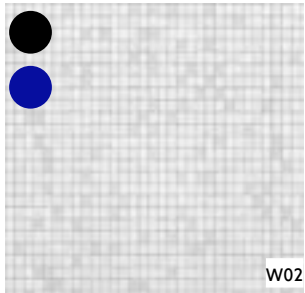

W02: White mosaic tile with dark grey grout.

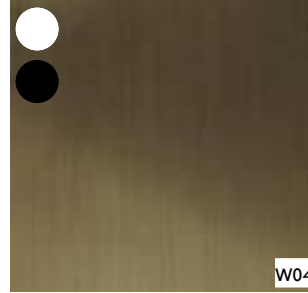

W04: Bronze finish stainless steel panel in vibration/brushed finish. Panel fixed using proprietary cladding system with 20mm shadow gap to all sides.

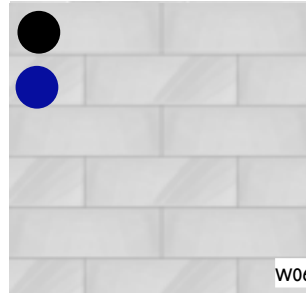

W06: White 100mm x 300mm glazed ceramic tile, laid in horizontal/vertical stretcher bond.

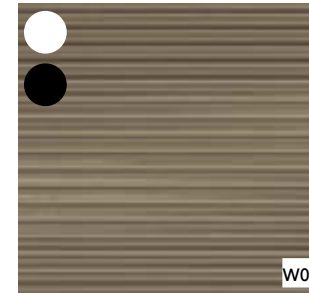

W08: Bronze finish profiled stainless steel panel in vibration/brushed finish. Panel fixed using proprietary cladding system with 10mm shadow gap to all sides.



W10: White back painted glazed panel, secret fixed using proprietary cladding system.



W11: Travertine stone panel fixed using proprietary cladding system with 20mm shadow gap to all sides.

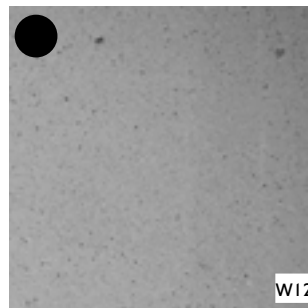

W12: Precast concrete panel fixed using proprietary cladding system with 20mm shadow gap to all sides.

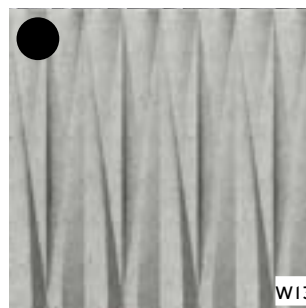

W13: Textured precast concrete panel fixed using proprietary cladding system with 20mm shadow gap to all sides.



W14: In-situ concrete with 20mm shallow gap recess to all module edges. Concrete to be cast in 600mm wide module pattern to match wall panels.

## Ceilings

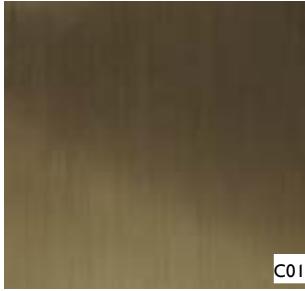

C01: Bronze finish stainless steel panel in vibration/brushed finish. Panel fixed using proprietary cladding system with 20mm shadow gap to all sides.



C03: Blue stainless steel panel in vibration/brushed finish. Panel fixed using proprietary cladding system with 20mm shadow gap to all sides.

## Ceilings/tunnels



C05: Metal tunnel forming rings, dark grey/silver finish.

## Floors and coving

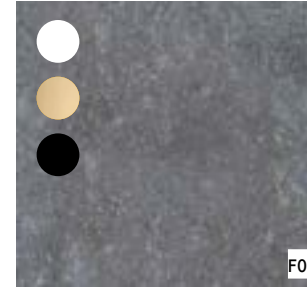

F01: Dark grey terrazzo floor tiles with contrasting coved skirting.

## Tactile

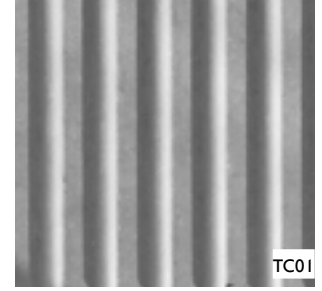

T01: Dark grey/black concrete corduroy tactile paving stone.

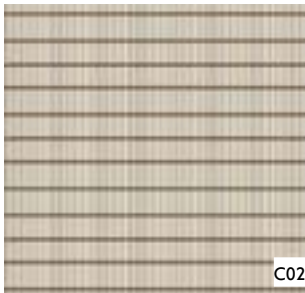

C02: Bronze finish woven mesh stainless steel panel in vibration/brushed finish. Panel fixed using proprietary cladding system with 20mm shadow gap to all sides.



C04: Blue woven mesh stainless steel panel in vibration/brushed finish. Panel fixed using proprietary cladding system with 20mm shadow gap to all sides.

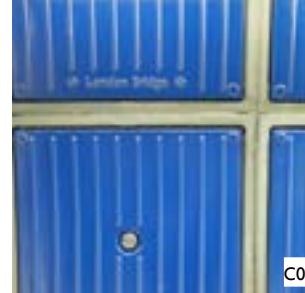

C06: Metal tunnel forming rings, self finished with blue inset panels.

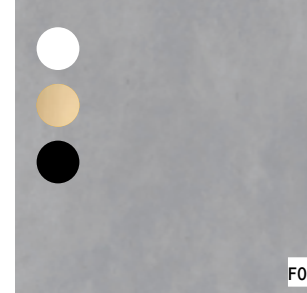

F02: Dark grey precast concrete paving stone with contrasting coved skirting (platforms only).

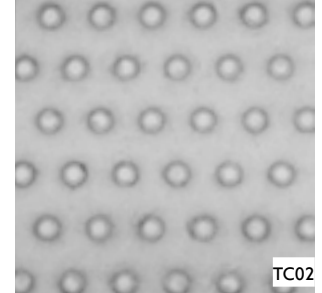

T02: Dark grey/black concrete blister tactile paving stone.

## Stairs & nosings



N01: Cast metal floor plate with silicon carbide granules cast in.

## Trim



Bronze finish stainless steel edging strip in vibration/brushed finish.

## Paint



White paint finish  
NCS 0502-Y.



White paint  
(platform edge lines).



Non-slip yellow paint  
(platform edge lines).

## Visual contrast (30pts)

Visual contrast of 30pts required. Examples shown for illustrative purpose only.

○ White finish in same material.

● Black finish in same material.

● Stainless steel panel blue vibration/brushed finish.

● Stainless steel panel bronze vibration/brushed finish.





# 6.5 Applying the materials

## The materials in the palette should be applied to the different types of spaces in the station.

The type of materials used in a station depends on the type and volume of the space:

- Ticket halls and concourse spaces: small single storey or large double storey
- Routeways: tubes or boxes
- Escalators, stairs and vertical circulation: tubes, boxes or shafts
- Platforms: tubes, large or small, or cut and cover or open section

Contrast materials and colour between spaces to enhance the sense of moving from one type of space to another.

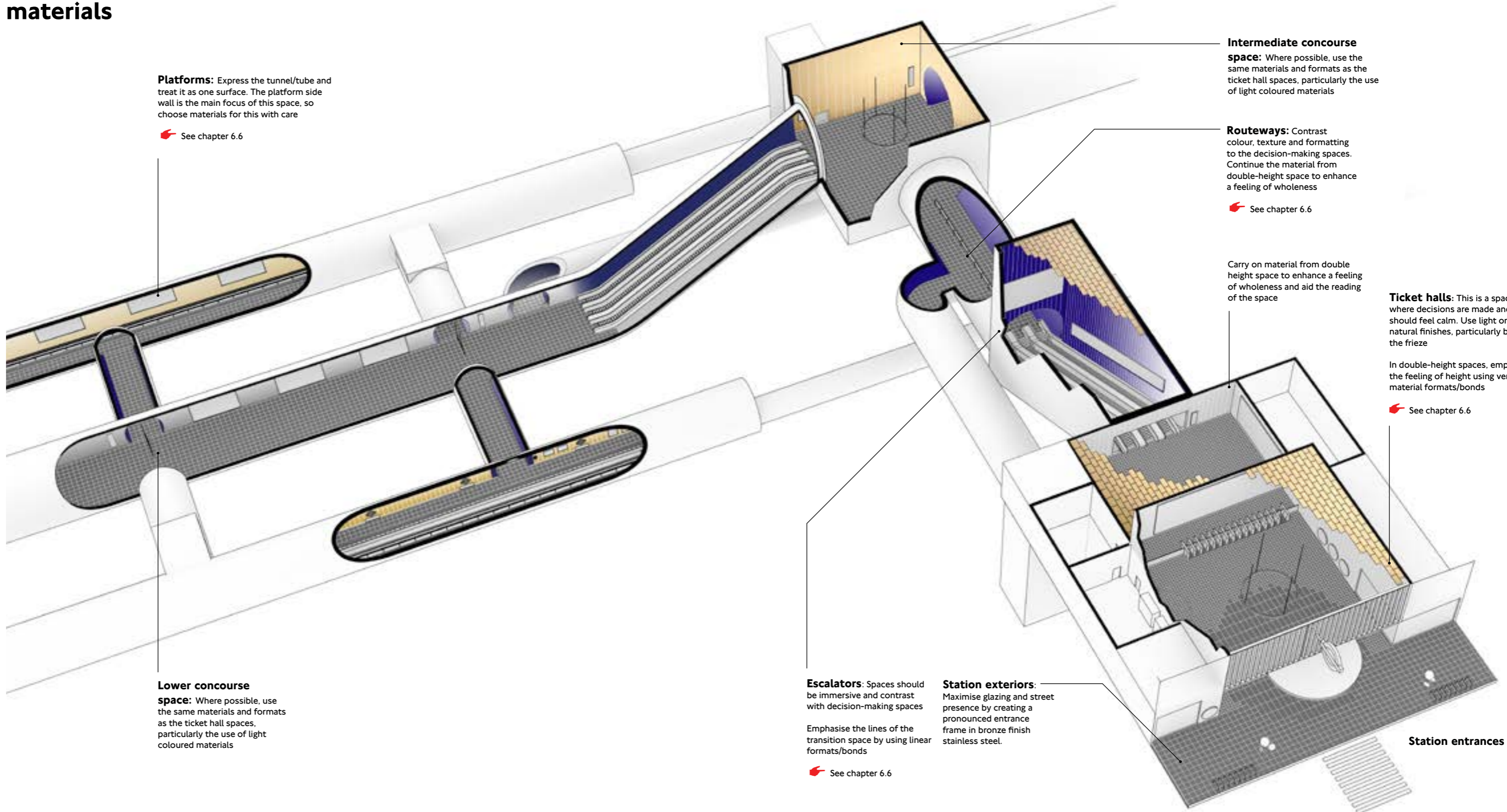

**Platforms:** Express the tunnel/tube and treat it as one surface. The platform side wall is the main focus of this space, so choose materials for this with care

See chapter 6.6

**Lower concourse space:** Where possible, use the same materials and formats as the ticket hall spaces, particularly the use of light coloured materials

**Intermediate concourse space:** Where possible, use the same materials and formats as the ticket hall spaces, particularly the use of light coloured materials

**Routeways:** Contrast colour, texture and formatting to the decision-making spaces. Continue the material from double-height space to enhance a feeling of wholeness

See chapter 6.6

Carry on material from double height space to enhance a feeling of wholeness and aid the reading of the space

**Ticket halls:** This is a space where decisions are made and should feel calm. Use light or natural finishes, particularly below the frieze

In double-height spaces, emphasise the feeling of height using vertical material formats/bonds

See chapter 6.6

**Escalators:** Spaces should be immersive and contrast with decision-making spaces

Emphasise the lines of the transition space by using linear formats/bonds

See chapter 6.6

**Station exteriors:** Maximise glazing and street presence by creating a pronounced entrance frame in bronze finish stainless steel.

**Station entrances**

## 6.6 The 2015 palette applied to ticket halls

**Ticket halls and concourses are the busiest spaces within stations, where passengers often need to understand an array of information and make lots of decisions quickly.**

They are used by many different groups, including those who are not necessarily travelling (eg for buying other tickets or shopping). Ticket hall materials should:

- Be of the highest quality
- Create an atmosphere of calm
- Be used to help make the space clearer
- Use light neutral colour or naturally finished materials
- Be considered in relationship to the lighting design in terms of their reflectivity



Mesh ceiling systems can help expand a space's sense of height, especially when ceilings are low

Routes that lead from the ticket hall should contrast in colour, tone and/or lighting to aid wayfinding

Place advertising in prominent head-on positions where it does not compete with customer information

Use dark flooring to help define the limits of space

Use contrasting materials to draw attention towards ticketing and customer information

Use a consistent signage band



## 6.6 The 2015 palette applied to routeways



Use tiling or mosaic to cover tight or complicated surfaces

Use contrasting materials and highlights of light to help guide customers

Use modular panels on repetitive surfaces

Use a contrasting skirting material

Make advertising appropriate. Use long format advertising to boost effectiveness and emphasise linearity

**Routeways are well travelled, although not used for decision-making as much as ticket halls.**

These spaces should contrast in their materials with adjoining spaces to help wayfinding and add a greater distinction between atmospheres of space. Routeway materials should use:

- Immersive colours
- More spectral finishes
- The same floor finish as adjoining spaces

## 6.6 The 2015 palette applied to escalators

**Circulation spaces, such as escalators, stairs and lifts, are less dynamic than routeway spaces as customers are often stood still for a period of time.**

These spaces often need to stand out so they are easy to orientate toward. Escalator, stair and lift materials should be:

- Dramatic in their use of colour and material finishes
- The same on all surfaces if a tubular form



Use an advertising format that works with the diagonal movement of this space

A consistent use of material on all surfaces to create an immersive experience

Use bronze materials to highlight the portal forms of the tube and create a transition with the onward space





## 6.6 The 2015 palette applied to platforms



The main focus of this space is the platform side wall so use a rich material here

Emphasise and differentiate between the entrance and information zone using materials or colour

When not fully wrapping the platform environment in one material, look to darker finishes to regress soffits and associated services

Grills to aid cooling on the Tube within the form of the tunnel

**Platforms require limited decision-making and are places where customers often stay for some time.**

They frequently have many services running along the ceiling and are the dirtiest of all the spaces. The materials used should be:

- More calm than in routeways
- Darker on the ceiling to hide dirt and equipment

Platform design tips:

- The main focus of a platform is the platform side wall so choose materials for this with care
- Emphasise and differentiate between the entrance and information zone using materials or colour
- When not fully wrapping the platform environment in one material, look to darker finishes to regress soffits and associated services

## 6.7 Station exteriors

**Our station exteriors are of primary importance both in terms of providing a strong street presence for our customers and as a physical statement of the Underground's brand and status.**

An important aspect of this is the architectural and urban context in which the station is situated.

The exterior elevation needs to be unmistakably Underground, confident in scale, proportion and style, yet not overbearing or gimmicky.

Station exteriors also have various operational requirements that must be considered and delivered appropriately, such as the roundel and vital customer information. To achieve these opportunities, the design needs to consider the form and function of the elevations, the relationship with the interior spaces, especially at street level, and, in particular, ensure that the best use of materials is drawn from the appropriate palette.

Consideration should be given to the massing, balance, proportions and juxtaposition of material, colour and textures both within the façade and in relationship to adjoining structures. Materials should be of the highest quality as our station exteriors are intended to be permanent and durable in service.



### Bricks

Bricks have a long pedigree of bringing architectural interest to Underground stations, from the earliest Victorian period of our history, through the outstanding 'Holden' period of the 1930s and also including more recent stations such as West Ham in 1999. Choose bricks that have colour and texture, being aware of their ability to improve with age. The bond and mortaring of brickwork is of critical importance and can deliver amazing designs and effects in a simple way. Glazed bricks can also be used to give a sense of depth and colour to a façade.



### Glass panels

Glass, and glazing details, often form some of the most memorable moments of Underground architecture, such as in the vast areas of 'Crittall' glazing found on our 1930s stations and modern stations such as Blackfriars.

Glass, either as traditional glazing, curtain wall glazing, or as glass bricks, can not only bring light to the interior of a station but also add transparency to a station façade. Glass can be embellished by etching or fritting to act as a decorative feature or a practical element as seen at Paddington (Hammersmith and City) station (2011/12) where the fritted pattern also acts to deflect solar gain.

Glass can also be used with laminate interlaying to introduce colour or opacity as required, but this should be positively exploited in a design and not over-used to produce a flat, potentially bland, façade. It should also be remembered that glass, at lower levels, can lead to issues when locating required furniture, such as poster frames and signs, which then have to be considered as free-standing elements in front of intended transparency.



### Natural stones

Stone, most notably the Underground's use of the 'civic stone' of London, Portland stone, has a long association with our station architecture and can be used to striking effect, as at Green Park station's southern entrance. Stone gives a sense of durability and solidity. Consider the stone's colour and textures, as well as its weathering abilities, and look to work with such inherent qualities to ensure the building ages with a patina and does not become careworn. The use of darker stones (such as granite) can act as a visual base to a structure as well as manage scuffing and dirt at lower levels.



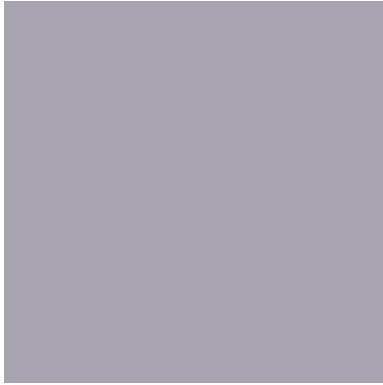

### Faience

Some of our most memorable and iconic stations are cloaked in durable and distinctive architectural faience, the 1906/7 Leslie Green stations being the most obvious. The material, when structurally bedded correctly, provides architectural elements that can appear almost plastic in nature, producing striking and colourful blocks of colour, enlivened by depth and the nature of the glazing, delivering moments of detail and entrancement.

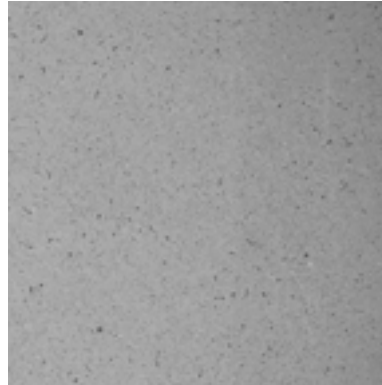

### Concrete

The Underground was amongst the earliest exponents of fair-faced architectural concrete in the UK, with Holden's use of the material in the landmark Piccadilly line stations of 1932/33. Concrete can still be a valuable component of our architectural palette, as seen in the Jubilee line extension.

In-situ concrete should be considered in terms of colour, texture, detailing and quality of pour and finish. The deliberate enhancement of moulding board details and of aggregate, intensified by polishing, should be explored. Pre-cast concrete can deliver a very high standard of workshop finish but care must be taken to ensure that blandness does not ensue. The impact of scuffing at lower levels should be considered, by using more finished products in these areas, as must be the requirement to develop patina rather than dirty appearances. The impact of anti-graffitti treatments on finishes such as concrete can alter the texture and appearance, and should be considered upfront.

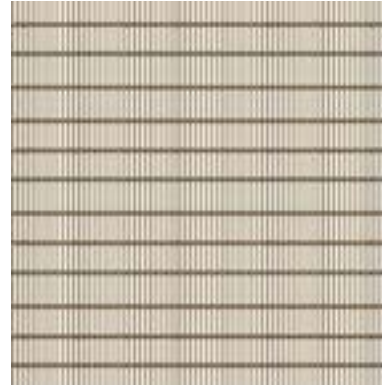

### Metal sheet cladding and meshes

Widespread use of metal and cladding is visible on Underground station interiors (such as at Farringdon's platforms) but is little used on external facades. These powder coated materials do not react well to exposed situations and so at low levels can be problematic. With careful consideration as to the correct materials, textures and finishes, they should, however, be explored.

Natural finishes can add vivacity to exteriors, as they change with lighting conditions (being careful not to introduce glare) and can, such as with self-weathering steel, become a long term asset. Metal and meshes (independently or as part of a laminated system) can also add a degree of 'porosity' to a façade, giving opportunity to introduce texture and patination to elevations, and can include the use of backlighting to add a sense of drama and interest.



### Rain screen and proprietary cladding systems

Limited use of such systems, using glass, terracotta, stone and brick slip, has been made on Underground stations due to issues with durability and maintainability in the harsh environment that station entrances often provide. These should be considered in terms of initial capital costs versus durability and maintenance costs over the whole life of the structure.



## 6.8 Getting the detail right

**The rest of this section applies to all stations on the network, not just the 2015 palette.**

### Tiles, mosaic and faience

Use tiles with a depth of colour created through their glaze. In new applications, use batches of tiles from different firings to create subtle contrast in colour and to make patch repairs less recognisable. Make joints in dark grey grout and to the British Standard.

### In situ concrete

When casting a smooth finish, use steel shuttering to create a highly finished surface. The panels should be in proportion to the space being formed and on a module to be in keeping with the other module sizes of the palette. When creating textured concrete, the more texture the better.

### Woven metal mesh

Mesh adds depth and texture to surfaces and, when properly lit, can become a real feature. Get the gauge of the mesh right for the scale of the space and consider the framing and fixing system to allow for easy maintenance.

### Trims, handrails and nosings

Trims should be formed from hard-wearing metals which glisten to add areas of highlight. The trim ties the various furniture and station items together and should therefore remain consistent through all parts of a station.

### Precast concrete

Precast concrete panels should be the same format as their in situ counterparts. Use finish of a high architectural standard and carefully consider the final texture, amount and type of aggregate, colour and level of polish. Think about casting in textures of natural materials such as stone, leaves or shells, to add further interest.

Also, consider using formwork which has been digitally created to make bespoke texture and patterns. A propriety cladding system should be used which can introduce accessible service voids behind for easy adaptation in the future.

### Metal panels

Hide joints between panels where fixings are located within shadow gaps between 10mm and 40mm; panel sizes should follow the same 600mm modules as other materials in the palette. Use a propriety cladding system.

### Natural stone

Choose natural stone from different areas of the quarry to make replacements less visible. This means that if panels need replacing, they will not stand out.

Panels should be butt-jointed with small gaps (10mm) and secretly fixed. A propriety cladding system should be used which can introduce accessible service voids behind for easy adaptation in the future.

### Floors and skirtings

Cove skirtings to make them easier to clean. Form them in natural stone or terrazzo to match the floor in the space (albeit in a contrasting colour).







CLAPHAM SOUTH STATION  
Exquisite tiling detail



## 6.9 Modular systems

**Go for modular systems rather than more continuous surface systems as they:**

- Offer greater flexibility
- Are quick and easy to install and replace
- Can be retrofitted in front of existing wall finishes
- Can be fitted to allow for preformed voids for services
- Can integrate access panels for services

Only use them on simple wall surfaces where repetitive elements are easy to install, without the need for too many special components which make them expensive.

➔ Find the Idiom flashcards in chapter 10.0



01  
TOTTENHAM  
COURT ROAD  
Circular tile design  
on the floor

02  
TUNNEL FORMING RINGS  
Used across the Jubilee  
line extension

03  
GREEN PARK  
Modular ceiling panels

04  
LONDON BRIDGE  
Tunnel forming rings with  
blue infill panels



# 6.10 Materials formats and setting out

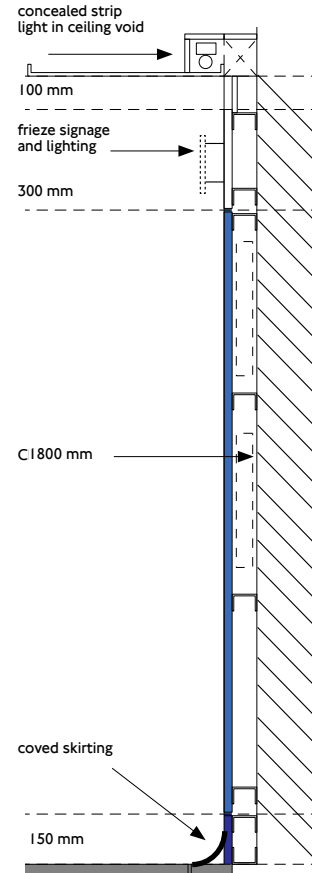
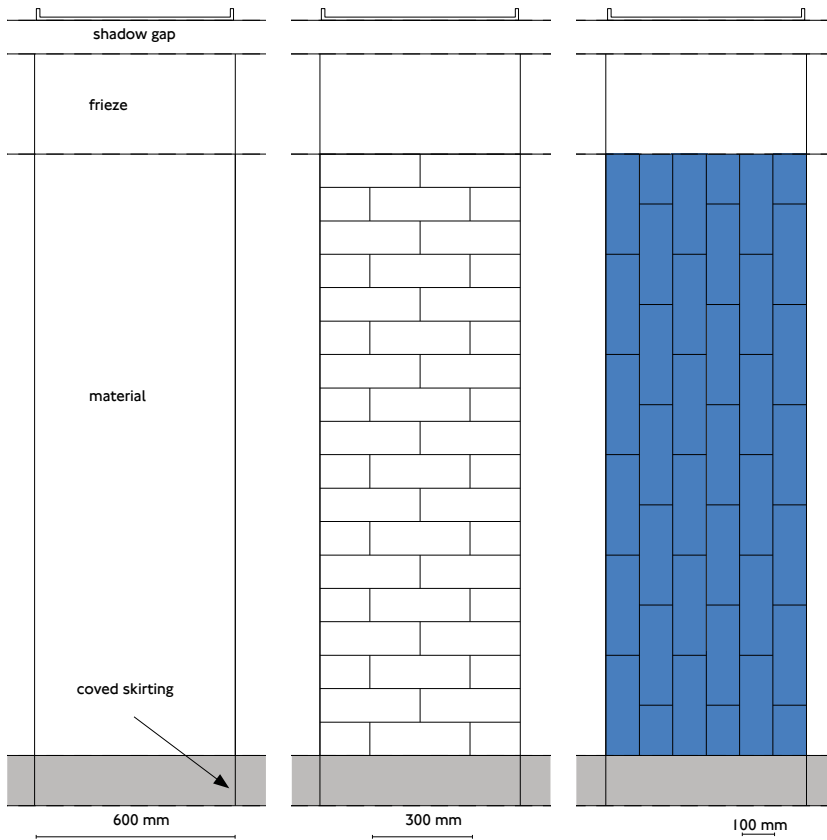

**The basis for many material modules on the network is 600mm. This is then sub-divided into smaller modules as required.**

All dimensions given are for setting out purposes to centre lines inclusive of jointing. They do not refer to tile or brick dimensions. All material and jointing dimensions must adhere to the relevant British Standard. Tiles must be metric modular standard sizes.

**MODULAR PANEL**  
Divide wall panels into 600mm wide panels which extend from the top of the coved skirting to the underside of the frieze zone.

**HORIZONTAL STRETCHER BOND**  
Lay 300mm x 100mm tiles in a horizontal stretcher bond in single storey and tubular spaces.

**VERTICAL STRETCHER BOND**  
Lay 300mm by 100mm tiles in a vertical stretcher bond in double storey and all ticket hall spaces.

Tiling must stop at the frieze to avoid risk of debonding.



The floor tiles are on a 600mm module, which is then sub-divided into 300mm as required.

- Lay flooring tiles in the main direction of travel
- Lay floor tiles in curved spaces to reflect the form of the space
- Circular ticket halls should have a tile pattern which radiates from its central point to the outer edge
- Use covered skirting no less than 150mm above the finished floor level
- Align the covered skirting with the flooring tile pattern

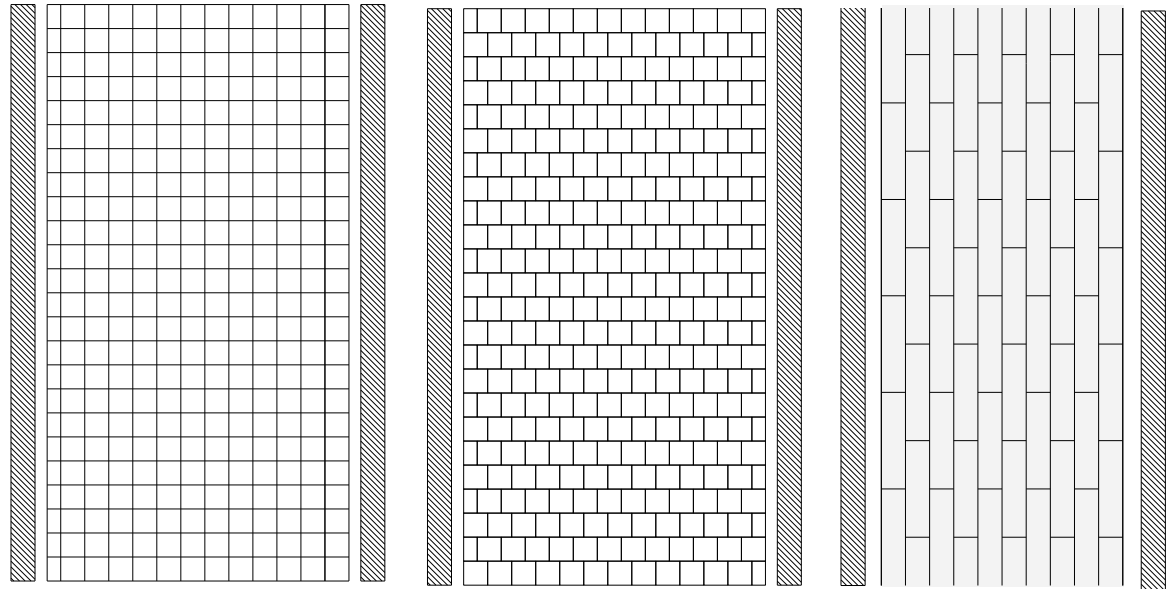

Rectangular spaces - tiles 300x300

Staggered rectangular spaces - tiles 300x300

Laid in plank format tiles 1200x300

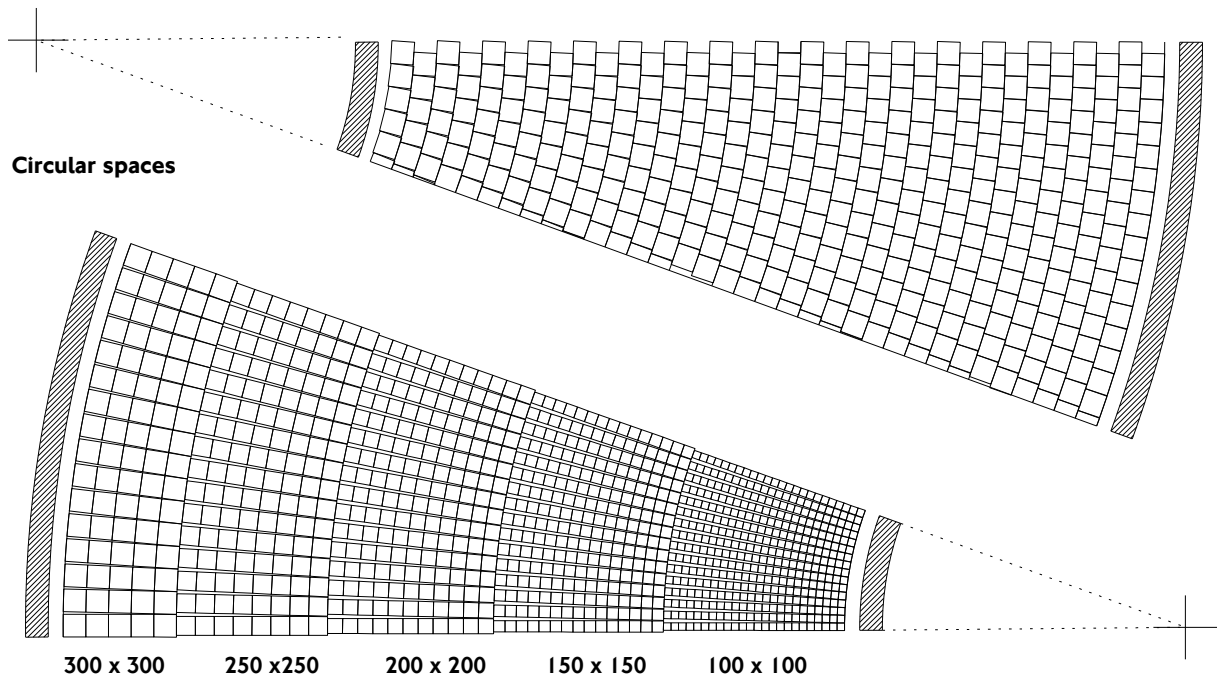

Circular spaces

300 x 300    250 x 250    200 x 200    150 x 150    100 x 100





## 6.12 Ceilings

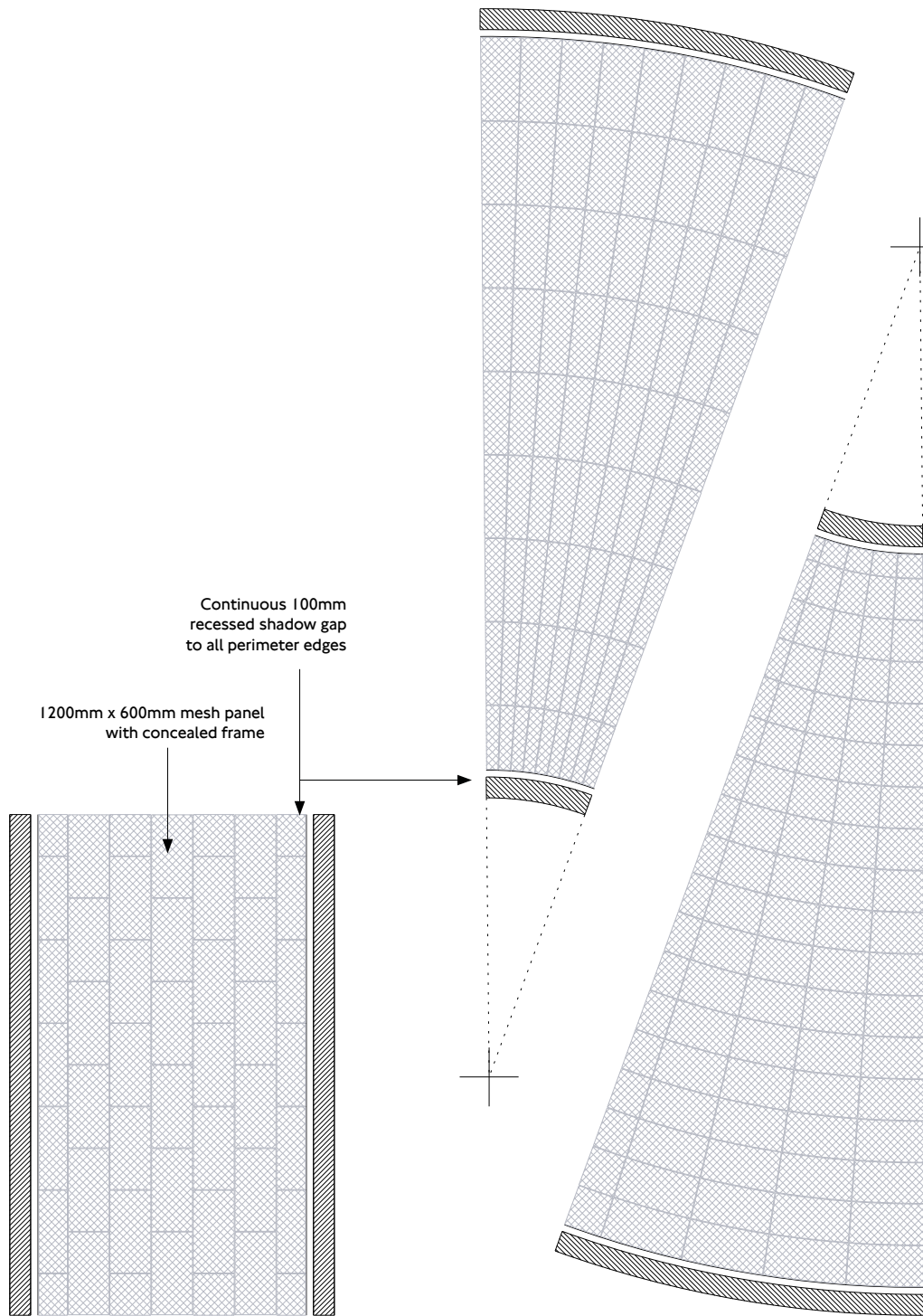

**Design ceiling panels to flow with the direction of the space they occupy and lay in a plank/ stretcher bond pattern.**

- The ceiling panels should be frameless when viewed from the underside
- Include a nominal 10mm recessed shadow gap between panels. At perimeter edges, ceiling panels should be cut to fit with a 50mm plate or angle in matching finish used to fit the panel
- Install a continuous shadow gap of nominally 100mm to all perimeter edges. This is often used to locate wall washing down lights



**Wall materials should be applied with regard to the frieze. Even if not installed, the frieze is an important continuous feature to be carried through the station.**

The fixing of materials, tiles and wall panels within these confines allows easy retrofitting of signage. Set out wall materials from the underside of the frieze, in modules as shown. The coved skirting at the base should take up any tolerance required.

**Columns and supports will be formed in various ways dependent on construction requirements and techniques.**

They should, in terms of dimension, shape and proportionality, react to the architectural and design context in which they are found.

The visual appearance of columns and supports – the use of materials, colour and the physical shape, can play a vital role in helping to determine the nature and 'feel' of a space, especially in constrained sub-surface spaces. They can, when correctly designed, become a feature; badly designed and finished they become overbearing and clumsy.

Columns can also appear as major features of stations – consider the central support column at Arnos Grove ticket hall, the central columns of Canary Wharf station that both visually inspire the space and unify all levels of the station, or the platforms at Aldgate East where the columns provide a degree of rhythm to the space and where the contrast has been thoughtfully integrated in the material and colour palettes.

Thought should also be given to the treatment of the base and capital, and how these are integrated or distinguished from the floor or ceiling. Columns can play an important factor in the physical flow of people around spaces.

The biggest challenge in determining the finishes of columns and supports is frequently the application of material to curved or 'short' elevations. This can preclude the use of materials such as ceramic tiles due to the amount of cutting needed, despite the orientation of coursing, which can lead to an overly complex, fragmented appearance.

Consider using more flexible materials, such as mosaic tesserae, or rolled and formed metal cladding, to help provide a more unified appearance. When using panelling or cladding, consider the fixing systems (so as to allow for removal for inspection) and especially the joints as these should be positioned and designed so as to help emphasise the design and detailing of columns and supports, not 'fight' against it.

Regarding colour, the column or support needs to be considered in terms of the adjoining or contextual palette and how the column and the visual 'weight' the architect or designer feels needs to be emphasised. Colour and material must also be used to design in any requirements for visual contrast that may be required, so as to avoid the look of a post-design 'application' of such features or requirements.





01



02

**Stairs, and their components, are areas of stations that are often most daunting and challenging to our users and have, like the building as a whole, very specific design requirements led by both London Underground Standards and UK legislation.**

During station refurbishments all opportunities to improve compliance in these areas should be taken – by use, for example, of intelligent adaptation of existing features. In new stations, compliance is absolute and must be delivered in such a way as to ensure the stairways form part of an harmonious and continuous design vocabulary throughout the station. The latter is an important point as, for many users who are visually or physically challenged, such continuity of design and appearance is both welcoming and reassuring and at the same time provides all users with the feel of a well designed and managed space.

In new stations the tread, rise and going of a staircase are determined by Standards and Building Regulations. In existing stations, such features are often sub-standard, and, short of complete reconstruction (which is rarely feasible), the intelligent use of materials such as both the background floor finishes and the treads and risers, that use contrasting colours drawn from the station colour palette, can deliver improvements in both appearance, use and maintainability. For example, inset colours to treads and nosings that can deliver an inherent colour contrast, should be drawn from the same colour palette that includes the handrail colours.

Handrails should provide colour contrast to their background and the initial choice of colour should be used to deliver this. Handrails, where new or replaced, should provide double height and be warm to touch. The colour and materiality should be drawn from the appropriate flashcard.

In Listed or heritage stations, handrails if replaced or adapted could use the original material, e.g. bronze tube or timber, but be recreated to provide a more compliant solution. In situations where wall space is confined, the position of handrails must take precedence and other requirements and uses, such as poster frame positions, must follow.

The lighting of staircases is often difficult to achieve in that the lighting levels need to be adequate at floor level. When designing lighting, changes in levels, such as the top and bottom of staircases, and intermediate landings, should be adequately denoted. It is equally important to deliver lighting at head height that does not produce glare. Consider intelligent delivery of lighting sources that are being explored such as inset, low-level lighting, or illuminated handrails.

01  
Proportionate platform columns at Aldgate East with integrated manifestations

02  
Stair nosings, handrails and wall detail working together



## 6.14 New works in existing stations

**A new piece of work can range from replacing a wall, ceiling or floor finish, to the integration of an entirely new ticket hall. These interventions can often cause unsightly and difficult to manage tide marks.**

The design approach to managing these interfaces depends upon the context and is subject to these guidelines:

- Use the network station design types map to establish the station design type and appropriate flashcard
- Note both the materials used and how they have been applied, such as the bond and format
- Establish any heritage or special station features and seek heritage advice if appropriate
- Identify how colours are used and for what purpose, such as for highlights, as a base, or for feature elements
- Ensure new materials are harmonious with the original character and design of the station and are of a high quality and of either a contemporary design which uses the existing materials in new ways, or one that mirrors the existing station materials and features
- Continue important datum lines to give visual rhythm and continuity
- Carry finishes the length of a wall up to a change in direction; a ceiling until a step in level; a floor until a threshold or any whole space
- Use a distinct trim, edging or recessed shadow gap to create a clear line of division between the old and the new



01  
FINCHLEY CENTRAL  
The new lift shaft (at the back of the photograph) was clad in slate tiles to match the existing station roof







**When repairing an area, match the existing material, including its format, colour and texture.**

Set the material in the same manner as the original, matching components such as grout colour, screws or bracket fixing.

Temporary works should be neatly designed and managed to minimise disruption to passenger flows and accessibility.

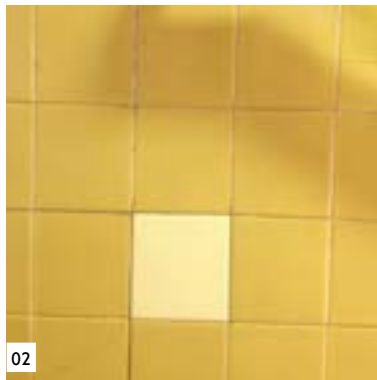

**01**  
BETHNAL GREEN  
An area of new tiles has been seamlessly matched to the retained ones

**02**  
BARBICAN  
A tile has been badly colour-matched and stands out, showing a lack of care for the network

**03**  
BELSIZE PARK  
Replica tiles based on the original station design



## 6.16 Case study: applying materials to an existing station – St James's Park station



The Palmer Street exit at St James's Park has been designed to harmonise the western exit of the station (on Palmer Street) with the main entrance at 55 Broadway. This has been done in a contemporary design language by applying the principles and materials of the Idiom.

The space has been re-modelled by utilising the space to the side of the existing ticket gates to increase capacity and extend the ticket gates further.

The theme of travertine wall panels is continued from the 55 Broadway entrance and detailed to appear to slide beyond the ceiling finish of bronze mesh, where a continuous lighting strip is concealed.

The dark floor finish of terrazzo tiles contrasts strongly with the travertine wall panels and makes them stand out with a bronze finish covered skirting in-between.

The ceiling mesh gives a sense of the higher headroom above whilst helping to mask the services suspended from the ceiling and is laid in long thin panels which flow in the direction of travel.

The overall composition is one which feels comfortably at home in St James's Park Station whilst being clearly contemporary and special.



01  
ST. JAMES'S PARK  
STATION PALMER  
STREET ENTRANCE:  
artist's impression

02  
ST. JAMES'S PARK  
STATION PALMER STREET  
ENTRANCE: today



**The Underground network is vast and diverse. Each station architectural type has a family of colours, materials and special features which should be used to create engaging atmospheres and elevate the experience of every customer journey.**

### **Important things to remember:**

- Each station on the network falls into an architectural category
- Use the appropriate flashcard to determine the predominant features and pallets
- Apply the materials and colours appropriately to the type of space
- Consider how materials are crafted and detailed
- Make new interventions into existing stations in the right way
- Ensure patch repairs match the original material



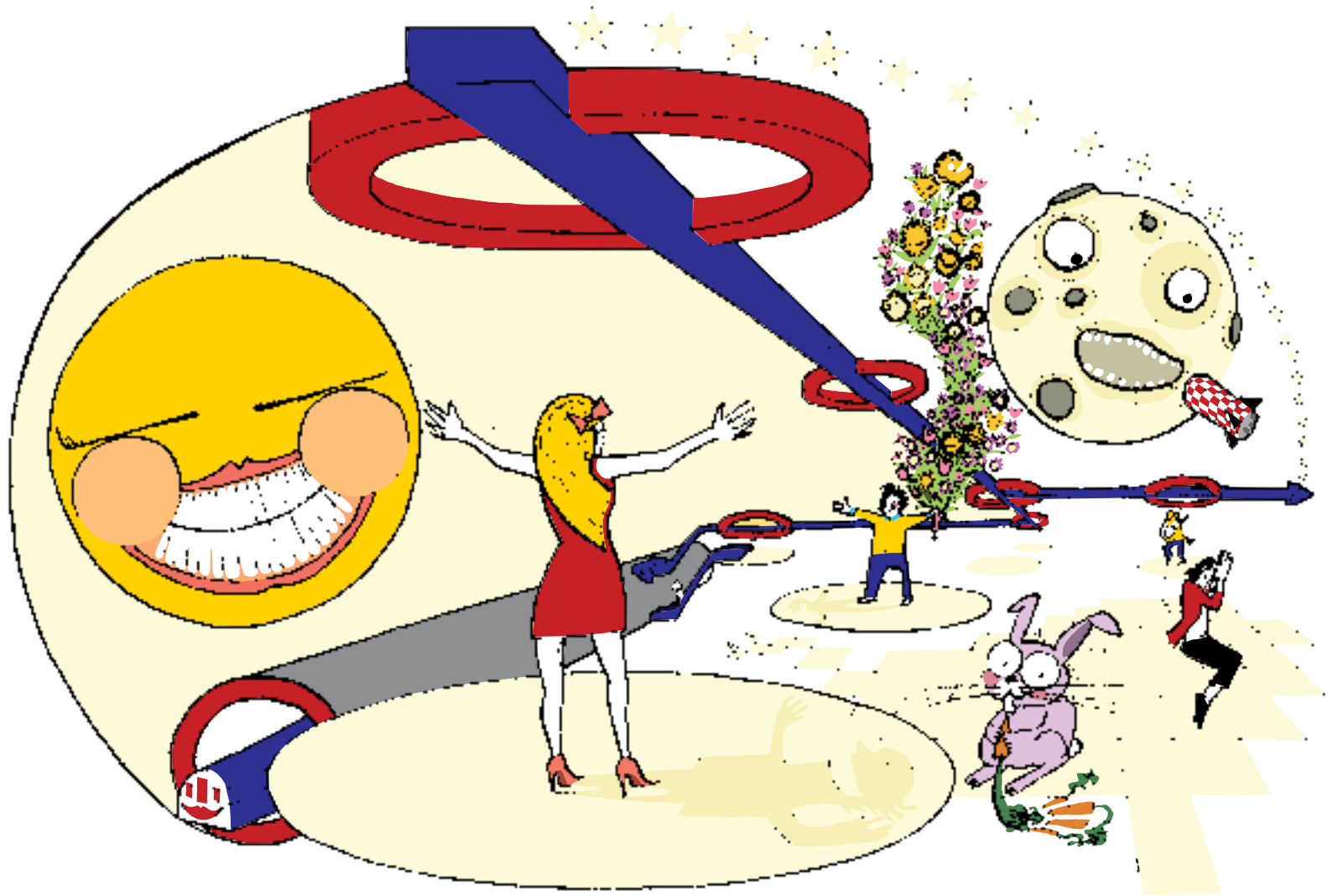



# 7.0

## Create ambience with lighting

Lighting on the Underground is used to make safe and functional environments, with maintenance and costs often dictating the choice and application of fittings with no consideration on how this impacts overall perception of space.

Although lighting must be functional to improve safety and increase feelings of comfort, it can also be transformational – improving spaces, drawing attention to heritage or special features and helping customers flow intuitively through a station.



## In this section:

- The importance of good lighting
- Applying the lighting principles
- Layers of light
- Understanding visual perception
- Lighting at a glance
- Lighting station exteriors
- Lighting ticket halls
- Lighting routeways
- Lighting escalators and stairs
- Lighting platforms
- Natural illumination in stations
- Adjusting from light to bright
- Lighting surface level stations
- Luminaire aesthetics
- Lighting controls
- Illuminance criteria and signage
- Lighting technologies
- The Night Tube
- Performance criteria



## 7.1 The importance of good lighting

**Good lighting can dramatically improve spaces and make a striking piece of architecture even more memorable.**

The naturally dark spaces of Underground stations offer opportunities to create distinctive lighting that can:

- Create positive emotional responses
- Make people feel safe (and even uplifted)
- Increase the quality of a space (from poor to mediocre, mediocre to good, and good to remarkable)
- Provide emphasis and highlights
- Aid orientation
- Create moments for the soul

Lighting should be thought of like a piece of music, using rhythm and composition to create moments of crescendo and changes of mood as well as moments of calm. It should always be considered in qualitative rather than quantitative terms and never overly used. It is not acceptable to over-light a space, just as it is not acceptable to under-light one; both can seem uninviting, uncomfortable and challenging in their own way.

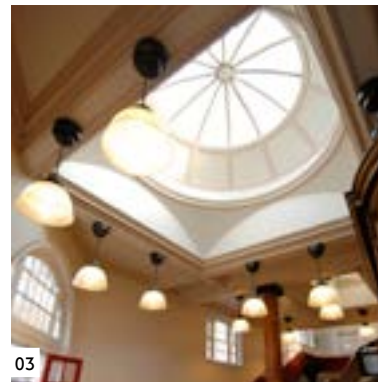

**01**  
CANARY WHARF  
The vast glass canopy at Canary Wharf delivers natural light deep into the ticket hall, with artificial lighting used to highlight the key station areas (escalators and platforms)

**02**  
SOUTHWARK  
The soft light from the simple circular 'port holes' in the escalators, mixed with the intense blue glass of the concourse above, combine to heighten the contrast between the two spaces and make for a dramatic travelling experience

**03**  
HARROW & WEALDSTONE  
Natural light highlighting the gateline.

**04**  
MUNICH WESTFRIEDHOF  
A simple platform space is transformed by the dramatic oversized lamp shades at the Westfriedhof station platform in Munich, which throw changing coloured light across a warm blue background



## 7.2 Applying the lighting principles

### Function first

Light should primarily be used to provide comfort, a sense of presence and the assurance of safety.

### Use light to orientate

Use leading lines of light to guide customers to areas of brighter light to draw focus and attention.

### Use layers of light

Use layers of light to elevate the visual composition and consider illumination on every surface to create a hierarchy of lighting.

**These principles can be blended with creativity and contrast to provide a dramatic, yet user-friendly space in line with exemplary metro stations across the world, such as HaffenCity in Hamburg and Westfriedhof in Munich.**

Both these projects shun convention and challenge design codes and guidelines; they ensure that lighting design is not just a tick box exercise. Instead, it is about the individual environment and ultimately the end user.

It takes careful planning and a fresh approach, but with consideration and an understanding of design, any space can be transformed.

### Create visual interest

Use light and illumination to highlight areas and to generate focal points of interest.

### Make it responsive

Use accredited control systems to make the lighting provide levels suitable for the task taking place within the space (such as security, maintenance and normal operation), while also maximising lamp life and minimising energy use and maintenance.

### Make it robust

Provide a robust, well-made lighting design, which is of high quality construction, vandal-proof and suits its environment. Use high quality light sources for longevity and to reduce maintenance costs.

### Conserve energy

Use efficient luminaires and light sources to reduce energy consumption. New lamp technology provides greater efficiency.

### Create station and network identity

Use light to create network and station identities, building on the individuality of London Underground stations. Ensure that lighting is sympathetic and complementary to its architectural setting, form and period.

### Make it suitable

Use lighting which suits the form and size of the space it's in and the materials, textures and colours used.





## 7.3 Layers of light

### Build up lighting in layers to add depth, texture and drama to station spaces.

Use the layers to aid passenger flow, define important areas and make wayfinding easier. Blend the layers together to ensure balance and contrast.

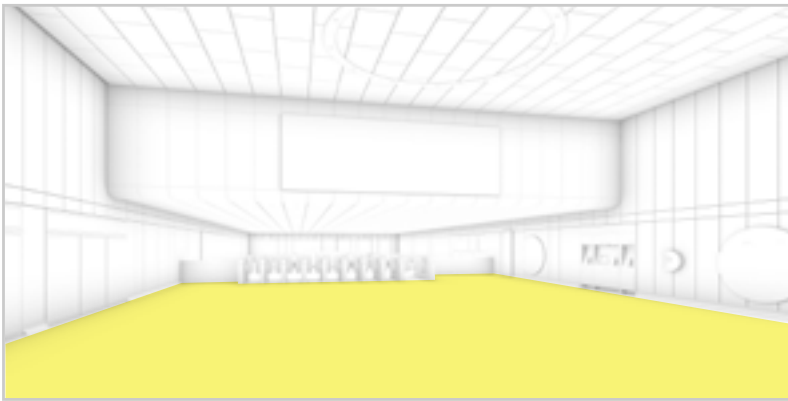

#### Layer 1: Ambient (Average 100lx/min 50lx)

The ambient layer is the basic background that provides functional and safe lighting across the space. Calculation surfaces should generally be considered in horizontal terms. In larger more open spaces it is equally important to provide adequate vertical illumination.

An initial base level of illumination throughout the station ensures the space is adequately lit, allowing customers to travel easily and safely.

Keep light levels at a minimum without compromising safety. This will maximise energy savings and the impact of the remaining layers of light.

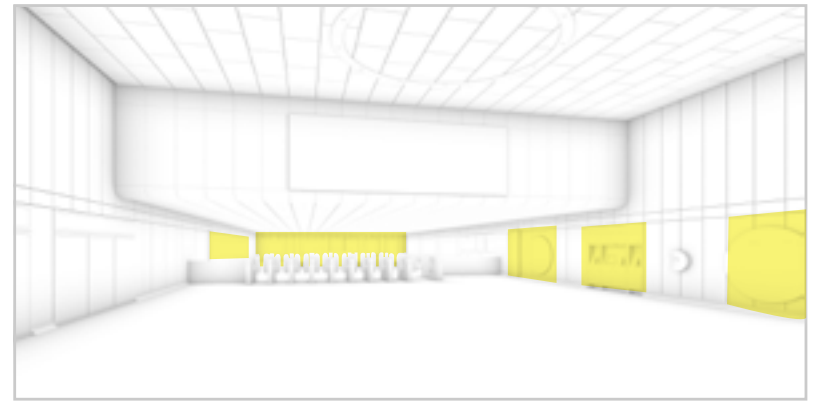

#### Layer 2: Accent (300lx)

The accent layer cuts through and lies over the ambient layer and provides visual emphasis on vertical surfaces such as walls. It also allows important areas such as ticketing or gatelines to be highlighted. There should be a balance of luminance/illuminance levels between the ambient and accent layers that ranges from 0.3 to 0.8 uniformity.

Use accent lighting to create visual hierarchy, with increased levels of illumination highlighting key routes and destination points.

Increase light levels in key areas and on key surfaces to draw customer focus. Use grazing light with low angles of incidence to accentuate unique forms and textures.

Accent lighting provides contrast, drama and rhythm and is therefore key to enhancing the customer journey.





### Layer 3: Orientation (100 lx/200lx to key areas)

Orientation lighting should aid wayfinding by instinctively drawing the eye through a space toward the next. Additional highlights at tunnel entrances and nodal points further aid circulation.

Use orientation lighting to delineate a space and aid customer navigation and wayfinding.

Create destination points at main junctions and at tunnel and walkway thresholds. This gives visual hierarchy, helping to clarify the space and aid the flow of customers.

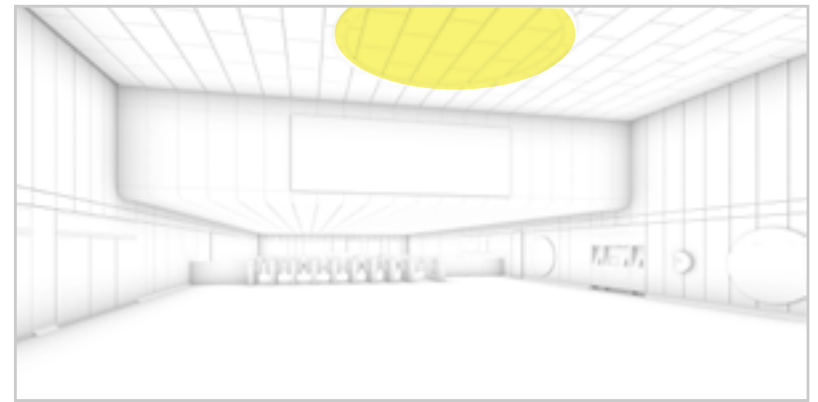

### Layer 4: Feature (300 lx)

Feature lighting provides an extra layer of visual interest; whether it is halos, chandeliers, or concealed, coloured illumination, it helps to create a focal area and adds visual stimulation.

Feature lighting can also contribute to the ambient, accent and signage layers. Feature lighting should always be appropriate to its setting, be it historic or contemporary.

Highlight feature elements within a space to celebrate special architectural features.

#### Note for all layers:

Generally, feature lighting is meant to be visible and can be a striking addition to the architecture of a space. Other layers should always be thought of as subordinate to the architecture.



## 7.4 Understanding visual perception

### Uniformity

Uniformity of illuminance is the ratio of the minimum illuminance level to the average illuminance on a given surface. When performing tasks, ensure the task area and its immediate surroundings have a sufficient level of uniformity.

#### Getting the balance right

Historically, Underground stations have been designed to a high level of uniformity, with a typical station ticket hall, for example, having a minimum uniformity value of 0.7 luminance/illuminance levels. These high levels of uniformity have also tended to lead toward the lighting being designed with a box-ticking approach, resulting in overly lit and uninteresting station spaces that place an undue emphasis on achieving uniformity across floor surfaces, rather than considering the way staff and customers move around and perceive a space.

#### Uniformity values should be as follows:

- A value of 0.5U<sub>o</sub> (uniformity units) should be used for the general ambient layer of lighting
- For accent and orientation layers of light the overall uniformity levels should be lower
- Uniformity should never be less than 0.3U<sub>o</sub> throughout the station

### Contrast ratio

For the accent layer of lighting to be effective, the luminance of the illuminated area should be higher than the luminance of its immediate background. Different luminance ratios give different strengths of highlights and shadows.

To ensure contrast ratios can be used effectively without introducing unnecessary glare, use a subtle to moderate contrast ratio of between 5:1 and 10:1 DIR.

### Glare

Glare is the sensation produced by bright areas in the visual field, such as brightly lit surfaces, parts of the luminaire itself, windows and/or roof lights.

Limit glare to avoid errors, fatigue and accidents.

#### Discomfort glare:

The rating of discomfort glare caused directly from the luminaires of an indoor lighting installation shall be determined using the CIE Unified Glare Rating (UGR) tabular method. The recommended limiting values of the UGR shall be 28 or lower.

#### Disability glare:

Any form of glare that directly impairs vision is disability glare and must be avoided. Disability glare is typically eliminated when discomfort glare limits are met.

#### Veiling or reflected glare:

Glare caused by reflections in specular surfaces is usually known as veiling reflections or reflected glare. Avoid veiling glare by ensuring all luminaires are correctly positioned and angled.



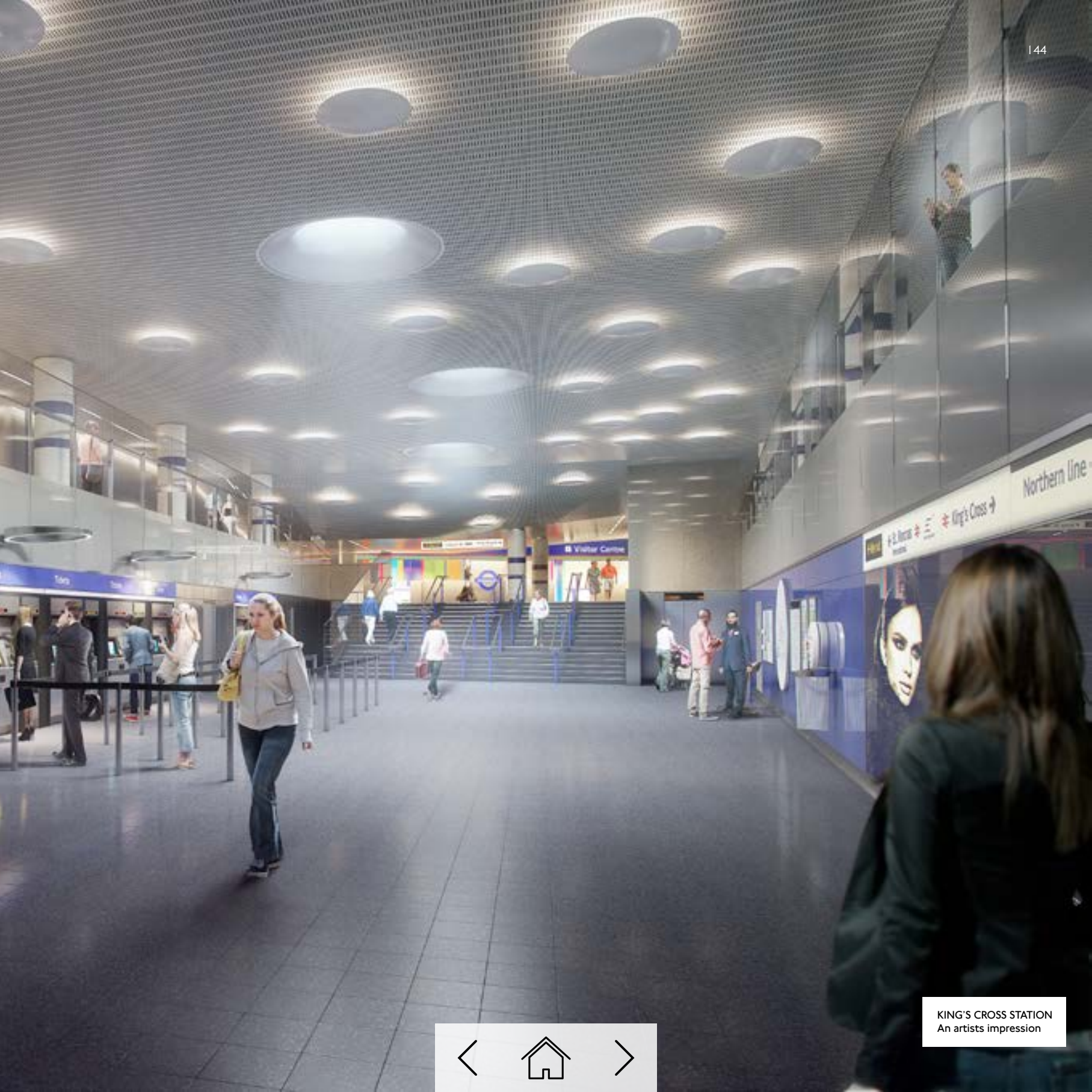

KING'S CROSS STATION  
An artists impression





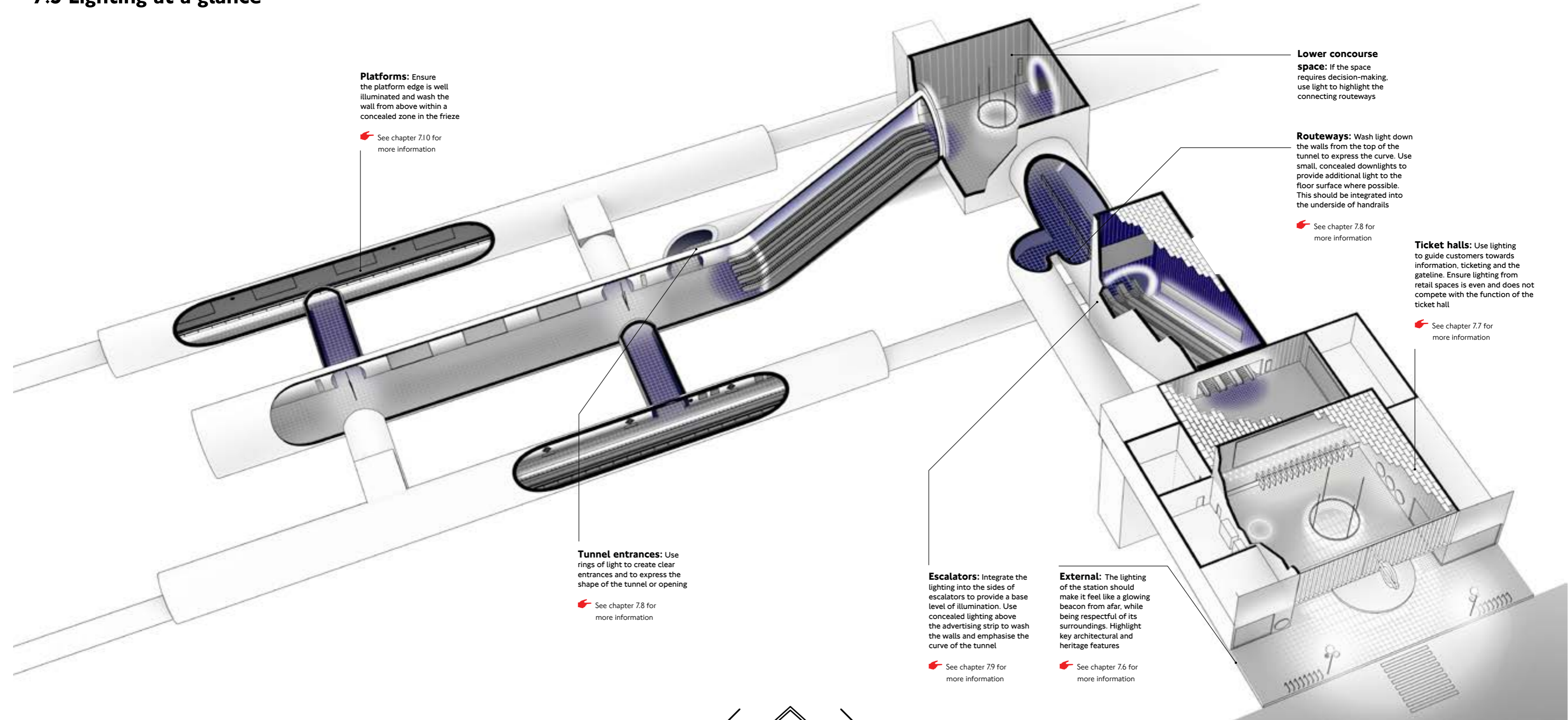

**Platforms:** Ensure the platform edge is well illuminated and wash the wall from above within a concealed zone in the frieze

See chapter 7.10 for more information

**Tunnel entrances:** Use rings of light to create clear entrances and to express the shape of the tunnel or opening

See chapter 7.8 for more information

**Escalators:** Integrate the lighting into the sides of escalators to provide a base level of illumination. Use concealed lighting above the advertising strip to wash the walls and emphasise the curve of the tunnel

See chapter 7.9 for more information

**Lower concourse space:** If the space requires decision-making, use light to highlight the connecting routeways

**Routeways:** Wash light down the walls from the top of the tunnel to express the curve. Use small, concealed downlights to provide additional light to the floor surface where possible. This should be integrated into the underside of handrails

See chapter 7.8 for more information

**Ticket halls:** Use lighting to guide customers towards information, ticketing and the gateline. Ensure lighting from retail spaces is even and does not compete with the function of the ticket hall

See chapter 7.7 for more information

**External:** The lighting of the station should make it feel like a glowing beacon from afar, while being respectful of its surroundings. Highlight key architectural and heritage features

See chapter 7.6 for more information

## 7.6 Lighting station exteriors

**Underground stations often compete with other lighting from the surrounding area. While the station should not add to light pollution, it is important that its lighting makes it clearly stand out as a publicly-focused building and as a neighbourhood beacon.**

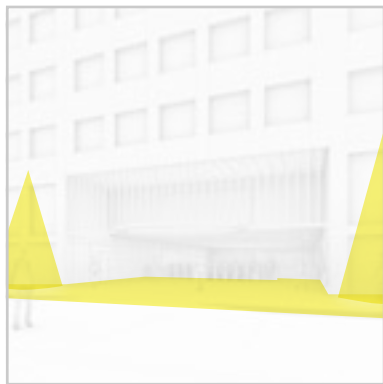

### **Ambient**

Introduce ambient light from street lamp columns and light spill from within the ticket hall.

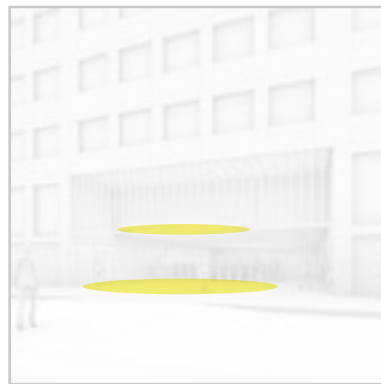

### **Accent**

Provide accent light beneath the entrance canopy to draw people into the ticket hall.

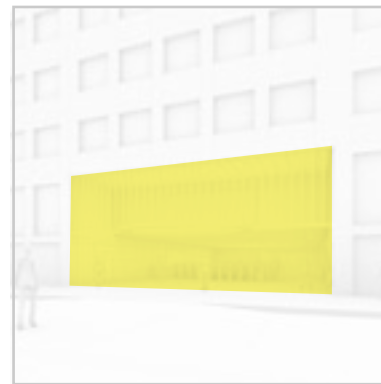

### **Orientation**

Highlight entrances by lighting the entrance reveals and threshold area.



### **Feature**

Highlight special architectural and heritage façade features and light the station façade to make it prominent.



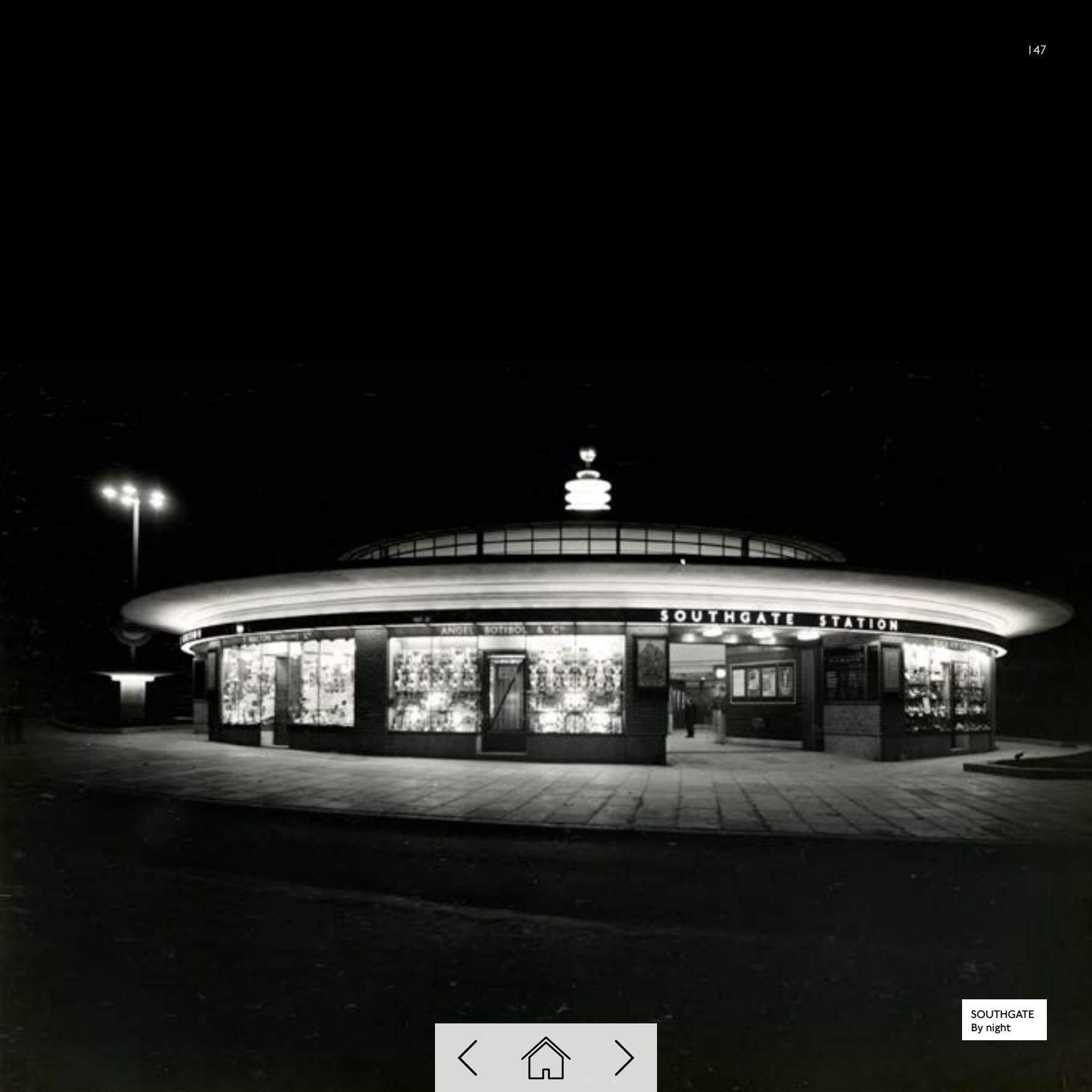

SOUTHGATE  
By night





## 7.7 Lighting ticket halls

**Ticket hall lighting should be bright and welcoming, with the key customer touch points of ticketing, information areas and gatelines highlighted. Use orientation lighting to draw customers toward routeways for their onward journey.**



### Ambient

Use ceiling recessed luminaires to wash the key vertical surfaces of the space, defining the space and making it feel bright and welcoming.

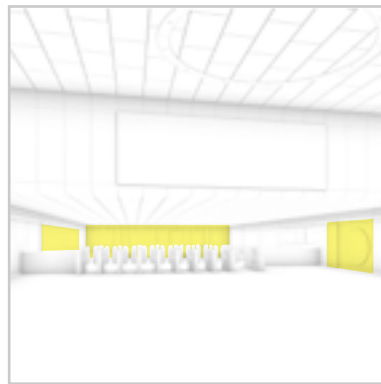

### Accent

Punch light over the key customer touch point areas of ticketing, gateline and customer information.

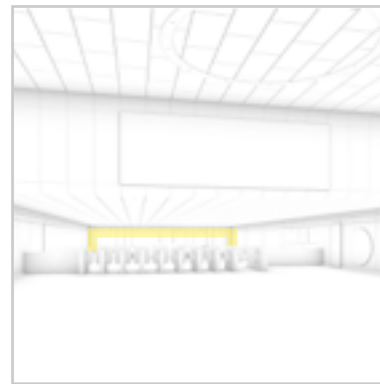

### Orientation

Highlight areas at the end of circulation routes into the ticket hall to draw customers onwards.

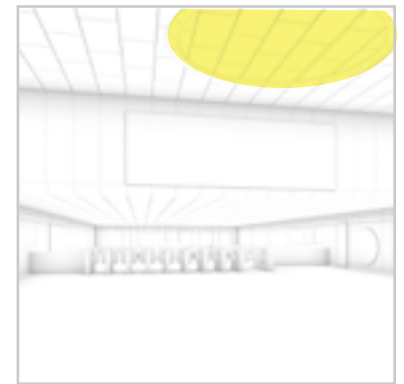

### Feature

Use lighting halos, chandeliers or other freestanding object lighting to create focal points. Highlight the special architectural and heritage features.





## 7.8 Lighting routeways



Lighting should be used in routeways to add interest to an often long and repetitive space. In tunnel spaces use lighting to accentuate the curve of tunnel and create atmosphere. Highlight the start and end points of the routeway and use lighting to give rhythm and definition to the space.

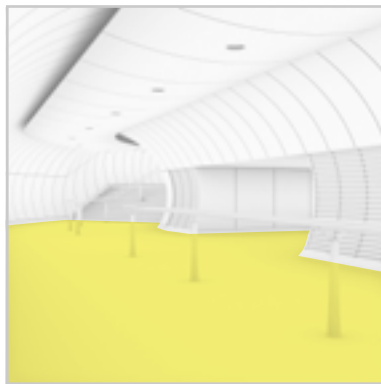

### Ambient

Apply a base level of illumination to the space and keep lighting levels to a minimum (safe) level. This will maximise energy savings, while allowing the other lighting layers to have maximum impact.

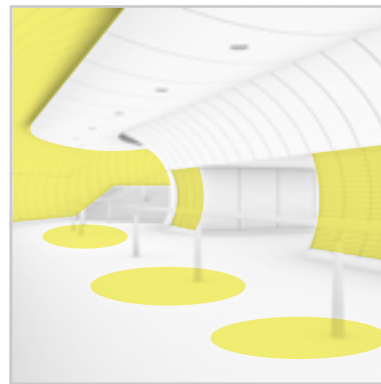

### Accent

Wash the wall surfaces of tunnels to accentuate their form.



### Orientation

Use orientation lighting at the start, end and the decision-making areas of the routeway to aid customer wayfinding.

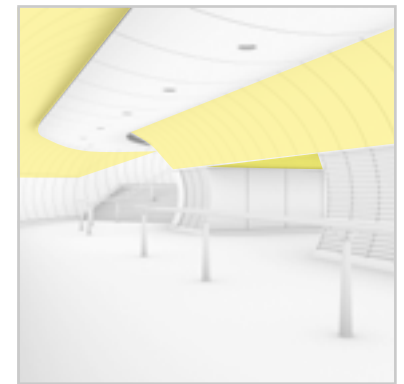

### Feature

Light the soffit to accentuate the form of the tunnel. Use coloured light to create visual interest areas.

## 7.9 Lighting escalators and stairs

Use lighting to highlight the areas at the top and bottom of stairs and escalators and to define the curved forms of tunnels. Integrate lighting into side panels, handrails or wall panels where possible.



### A note on advertising

Where digital advertising is present, the lighting scheme should take this into account. The lighting should provide a subtle backdrop to the screens to enhance the aesthetic of the space, without interfering with the advertising itself.

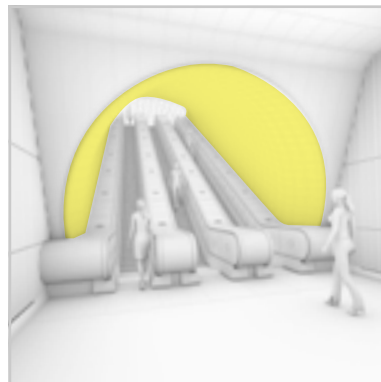

#### Ambient

Use integrated luminaires, concealed at the sides of the tunnel, to uplight the tunnel walls. This keeps the space clutter-free and retains the impact of any station-specific listed elements.

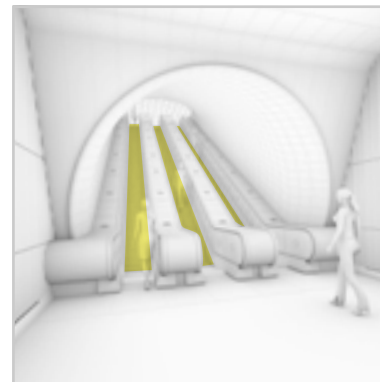

#### Accent

Integrate accent lighting at low level within escalator side panels and staircase handrails. This ensures the treads are well lit and makes it easier to access for maintenance.

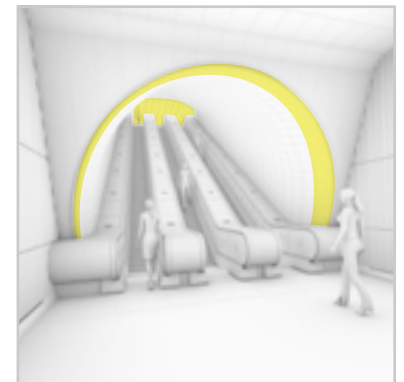

#### Orientation and feature

Create a feature at the top of escalators and stairwells to give a sense of direction and make it look more interesting.

## 7.10 Lighting platforms



**Use platform lighting to clearly define the platform edge and highlight the entrance and exit points. Integrate and conceal luminaires to avoid glare and visual clutter.**

### Note on platform edge doors

Where platform edge doors are installed, the luminaires should be concealed within the head channel of the doors. Ambient lighting levels can be less as there is no risk of falling onto the tracks.

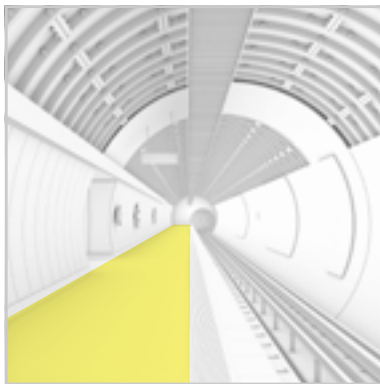

#### Ambient

Use concealed luminaires within the frieze zone to wash vertical surfaces with light, making the space bright, safe and welcoming, while ensuring that advertisements are well lit.

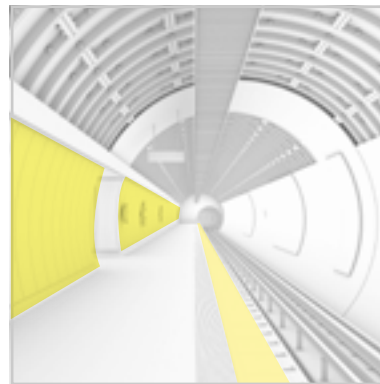

#### Accent

Use concealed downlighting above the edge of the platform to create a clearly defined platform boundary.

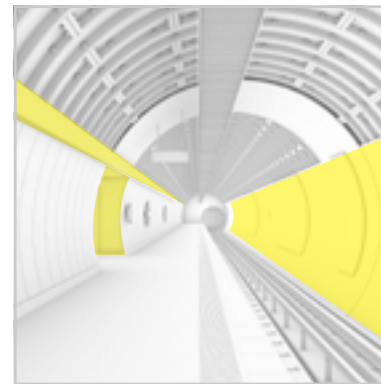

#### Orientation and feature

Use parallel linear lines of light to outline further information, aid wayfinding and strengthen the platform's identity.

Make the threshold of the platform entrances and exits brighter to ensure they are clearly visible and to aid the flow of passengers.

Use feature lighting to emphasise the form of the tunnel from within the central platform raft or frieze zone. Coloured light can help.





## 7.11 Natural illumination in stations

### Introduce as much daylight in as many areas as possible.

Maximise ceiling heights and the amount of glazing to let light penetrate deep into the station, beyond the surface level areas.

Where daylight does not provide enough light, use artificial lighting which is controlled to respond to the changing levels of natural light. This optimises lighting conditions and minimises energy use.

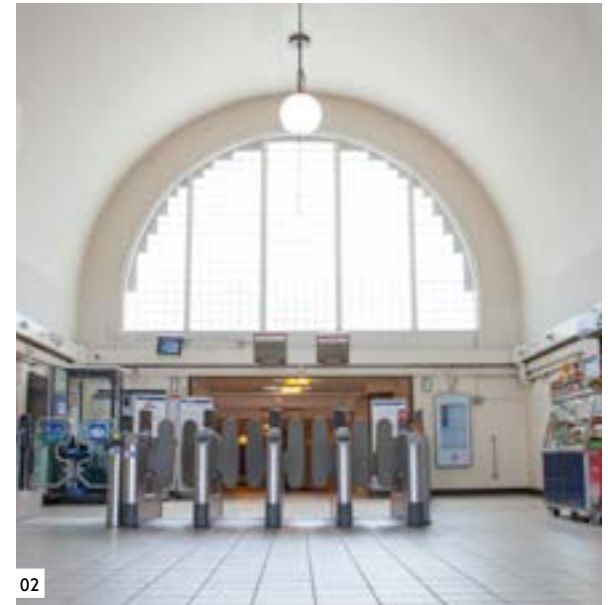

Examples of stations maximising daylight:

01  
MORDEN

03  
SUDBURY HILL

02  
LOUGHTON

04  
KING'S CROSS





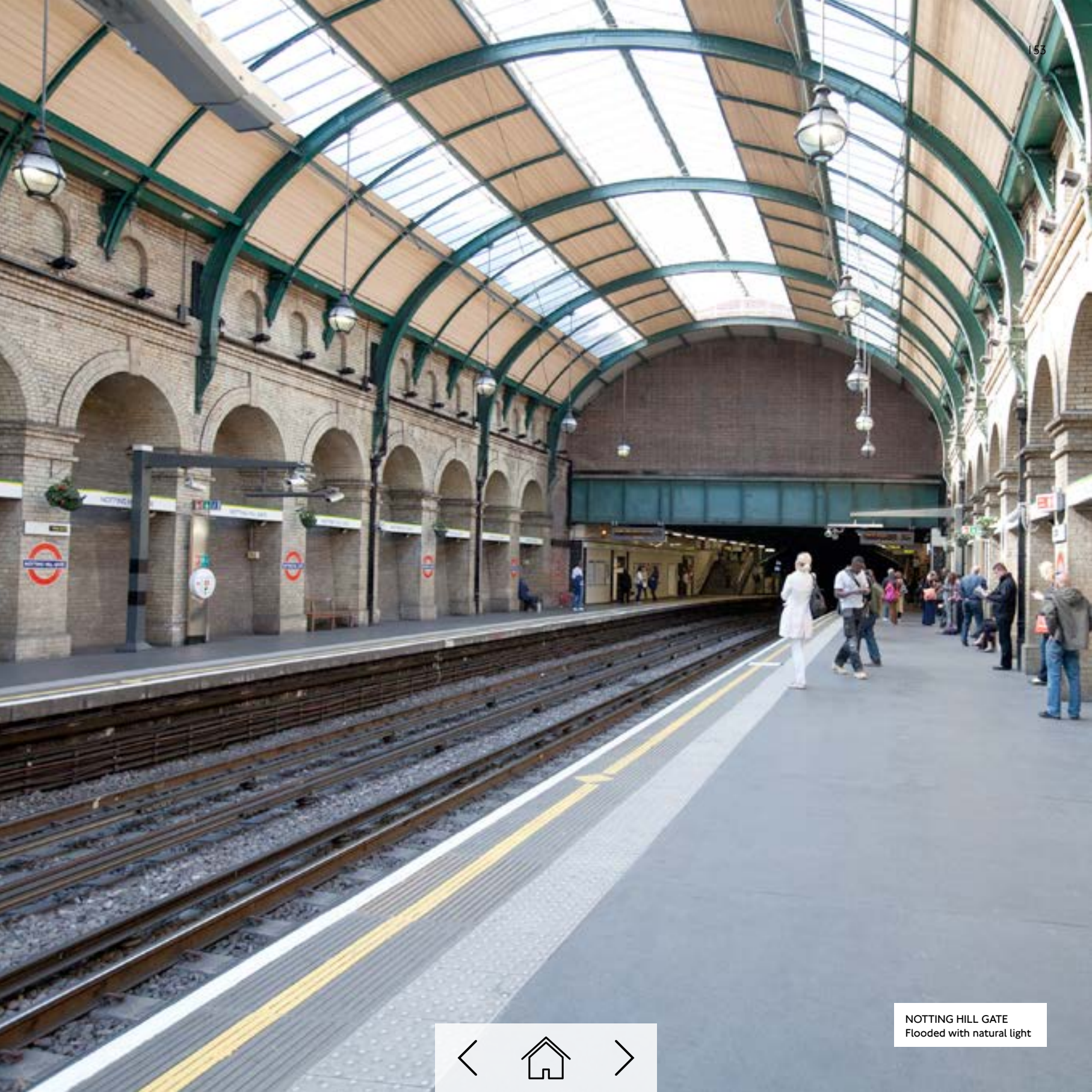

NOTTING HILL GATE  
Flooded with natural light



## 7.12 Adjusting from light to bright

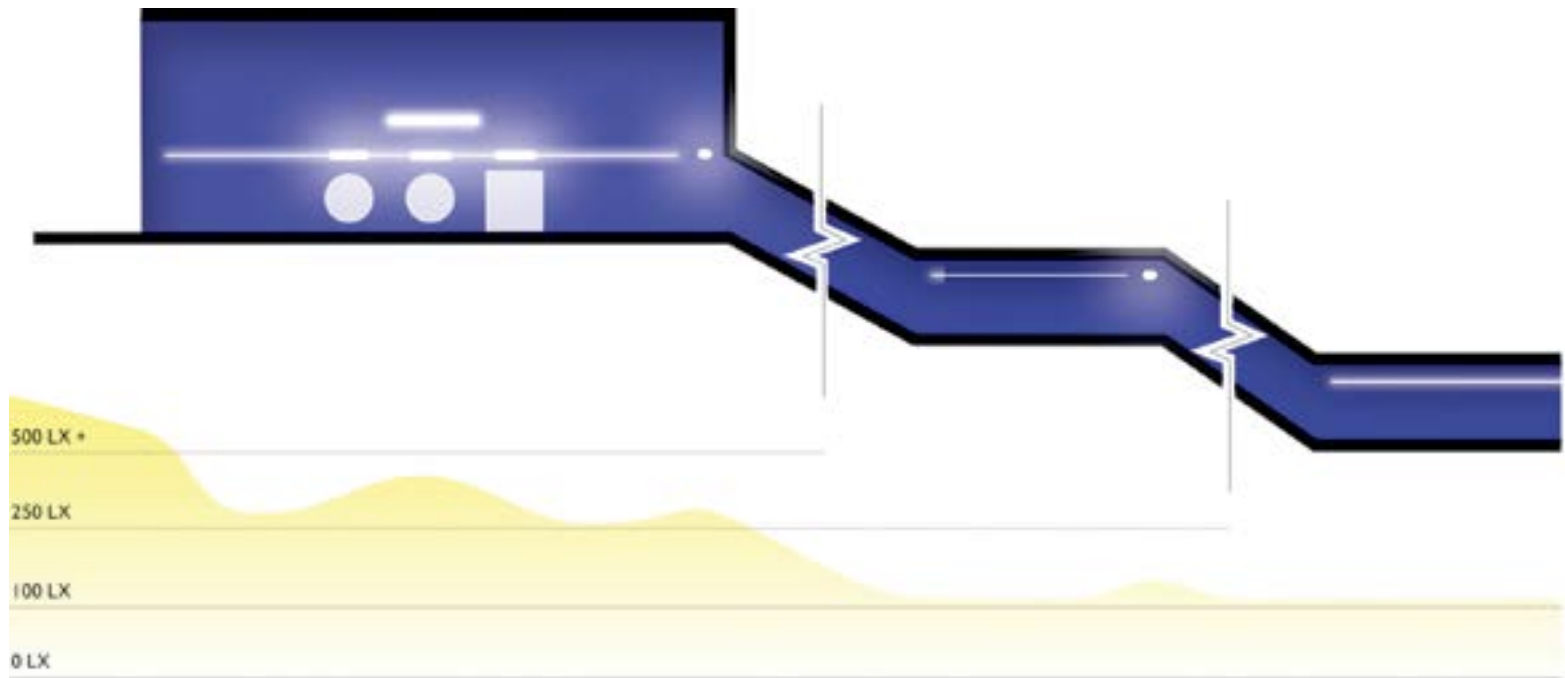

### **The human eye adapts constantly to changing levels of light, with sudden changes being uncomfortable or disorientating.**

Spread any large changes in light levels over a reasonable distance to allow the eye time to adapt. This is particularly important when designing Underground stations, as customers are often moving between darker and lighter areas (such as from a tunnel to a ticket hall).

The lighting in a station should always be considered hand in hand with the light levels of the immediate surroundings. Escalators and stairs play a key role in this transition as, in most cases, they form the first point at which users move into the network of tunnels from bright, and in some instances, daylight environments to darker ones.

In the same way that highway tunnel lighting is adjusted so that the start and end of a tunnel is brighter, the light levels along the escalators and stairs should be varied to ease the eye into the change in illumination.

Escalators should be brighter at the top than at the bottom. This change in lighting levels helps the eyes to adapt and aids orientation by creating a 'light at the end of the tunnel' effect.

Wash the surfaces at the top of the escalator with light, using either accent illumination or an illuminated feature such as a suspended decorative pendant.





**Use lighting to bring life and character to outside platforms. The same rules for interior platforms apply, but maximise the use of daylight where possible.**

### **Ambient**

Use luminaires concealed in the overhead structure to provide a base level of ambient illumination, while ensuring the luminaires are submissive to the architecture.

### **Accent**

Use accent illumination to ensure the edge of the platform is clearly defined during the hours of dusk and darkness to help reduce the likelihood of accidents. Introduce illumination to columns and vertical surfaces to ensure the station feels bright and safe at night.

### **Orientation**

Make the threshold of platform entrances and exits brighter to increase their visibility.

### **Feature**

Make any feature illumination station-specific using light to highlight historic and architectural features and strengthen the identity of the station.

## 7.14 Luminaire aesthetics

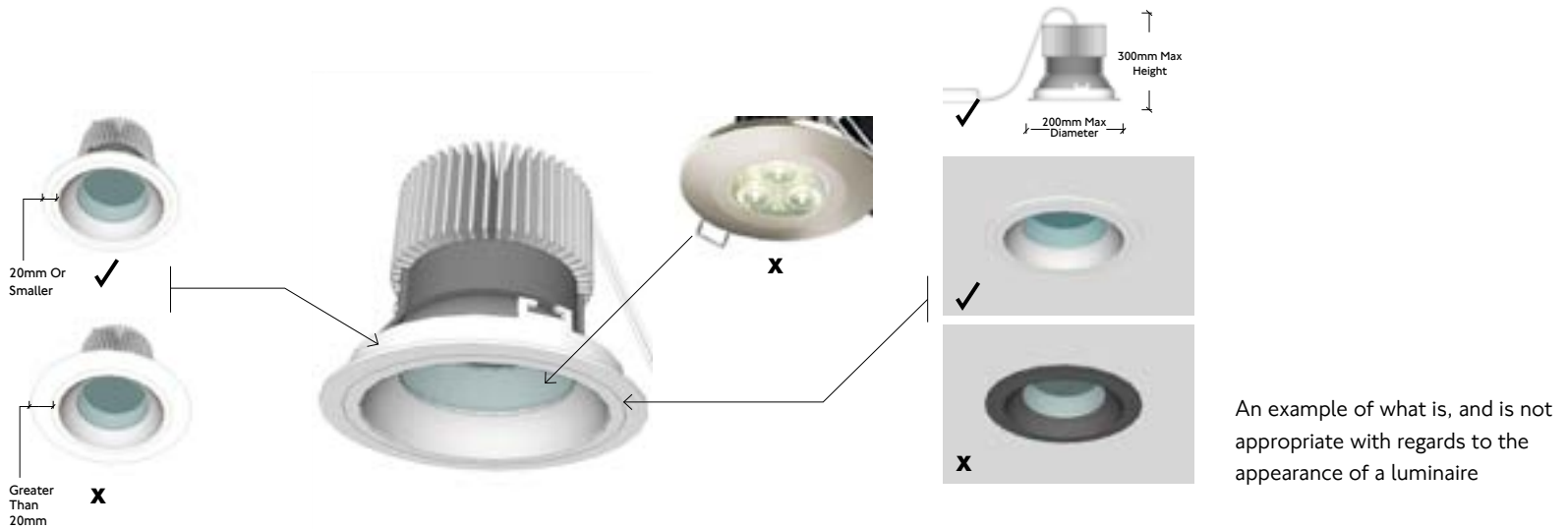

### Luminaire selection

Ensure all luminaires meet the photometric and electrical performance requirements and that all fittings are aesthetically appropriate to their intended location.

To achieve this, apply these rules:

- Choose luminaires appropriate to the architecture and period of the station
- Apart from feature luminaires, light fittings should be understated and submissive to the architecture
- Design finishes to match the surface the luminaire is mounted on or in
- Where luminaires have a trim or bezel, the trim should not exceed 20mm in width

- Downlight luminaires should use a deep recessed or otherwise obscured lamp source. Keep the visibility of lamps to a minimum to prevent glare
- Downlights should not exceed 200mm in diameter and where surface mounted should be no taller than 300mm, unless mounted above a height of 5000mm above finished floor level
- Ensure all luminaires within an area have the same colour temperature

➔ See chapter 7.15 for more information

### Reliability

Reliability of service is vital to the operation of the Underground and lighting installations should be designed with this in mind.

The reliability of luminaires is essential to ensure an uninterrupted customer experience and to project the right brand image. Luminaires and all associated parts (drivers, control equipment, etc) should be warranted and made to last, enabling savings and reductions in maintenance costs.

Use ambience and design to assist reliability. Considered lighting can be used to create a visual hierarchy which can influence customer movement within a station. For example, by ensuring platform exits are clearly highlighted, customers can be encouraged to alight from their train quickly, maintaining and improving reliability by easing congestion.

### Lighting control

Provide lighting control systems where possible to control illumination levels and minimise energy consumption. This may be via the use of daylight-linked dimming in areas with significant daylight or by ensuring luminaires are dimmed during the station's non-operational hours. Dynamic lighting can be considered in certain circumstances. Whether for additional feature lighting (colour changing), circadian linking (tonal changes) or to reduce energy consumption (dimming), such illumination techniques require a lighting control system.

Lighting control systems can be linked into the Building Management System (BMS) to provide feedback on energy consumption, lamp life/failure and autonomous time-clock and daylight linked dimming/switching control. Typical systems use the Digital Addressable Lighting Interface (DALI) protocol and can allow each luminaire to be controlled individually.







The following are all potential applications and benefits of lighting controls:

### Occupancy-linked dimming

Sensors detect the number of customers using the space to determine the level of light required. This ensures enough light is provided during peak periods, while minimising energy use and prolonging the lifetime of luminaires when it is quieter. For example, if no pedestrians are detected, there can be a 50 per cent reduction in light output.

### Daylight linked dimming

This is suitable for station areas where daylight provides some of the required ambient light. Sensors determine daylight availability and electric luminaires can be adjusted to top up to the required light levels, reducing unnecessary energy consumption.

### Dynamic lighting

Dynamic lighting can be linked to activity levels, special events, or other triggers. Tonal change can also be applied to enhance this effect, both gradually and dramatically. For example, there can be a gradual shift in colour temperature from 4,000K to 3,000K throughout the day to help customers stay alert in the morning and relax in the evening.

### Constant light output

This uses dimming to ensure a consistent level of light throughout the lifetime of the luminaire. It also provides lower energy consumption from the onset of operation. For example, if a light source is projected to lose 20 per cent of its light output after 30,000 hours of operation, to counteract the effects of the luminaire's depreciation over this period, the source can be under-run to 80 per cent at the beginning of use, and then gradually increased to 100 per cent output.

## 7.16 Illuminance criteria and signage

### Signage

**Internally illuminated signage should be installed wherever its electrical distribution can be adequately concealed, such as in new stations, or where concealed cable management systems are in place.**

When using internally lit signs, follow these rules:

- Internally illuminated signage is typically achieved with an array of linear sources. Due to heat dissipation and ventilation requirements, LED sources shall be used for their cooler operating temperatures
- The spacing of the linear array is important to ensure similar light to the surface of the signage
- Use a 1:1 ratio of spacing and distance from the surface to ensure uniform illumination

- A cooler colour temperature of 4,000K shall also be used to facilitate visual contrast with the architectural lighting
- The luminance of the illuminated surface must be controlled to ensure customers do not perceive it as a source of discomfort glare
- While the perceived brightness will vary according to light levels within the space, the maximum luminance of illuminated signage shall be 400cd/m<sup>2</sup>
- All illuminated signs shall be dimmable

### Other Signage

**Other signage should be illuminated to ensure that its information is visible and to help it to stand out from its surroundings.**

Follow these rules:

- Typical directional luminaires should be used to highlight signage to a minimum illuminance of 100lx with uniformity of 0.5
- Use luminaires with high colour rendering to illuminate signage. This maximises the contrast between the background and any symbols or lettering

- Luminaires with a colour rendering index below Ra80 should not be used; higher Colour Rendering Index (CRI) fittings should be used where possible
- Place luminaires where their line of focus does not exceed an angle of 30 degrees from the vertical. This ensures a good light distribution without reflecting the light source back into the visual field and also serves to reduce glare
- Signs and general ambient luminaires should not be placed too close together to avoid the risk of disability glare
- Where signage is suspended at high level close to the ceiling, grazing light down the face of the signage can be used to good effect

### Illuminance criteria

Area	Average Illumination Leves	Minimum Colour Rendering (Ra)	Uniformity Requirement (U0)	Unified Glare Rating Limit
Ticket Hall/Concourse	100	95	Circulation = 0.5 POMs = 0.7 Visitor Information = 0.7	28
Gatelines	300 - 400	85	0.8	22
Corridors/Passageways	100	85	0.3	28
Stairs and Ramps	150	85	0.8	25
Stair Landing	200	85	-	25
Escalators	150	85	0.5	25
Escalator Landing	200	85	-	25
Platforms	100	90	0.5	28*
Platform Edge Zone	300	90	0.5	28*

\*Special consideration should be given to avoid any glare to train drivers



## Choosing a luminaire

This table outlines which luminaire is appropriate to install in each station space.

LUMINAIRE	TICKET HALLS										ESCALATORS			STAIRS			ROUTEWAYS			PLATFORMS									
	Entrance canopy	Ceilings low	Ceilings high	Ceiling perimeter low	Ceiling perimeter high	Walls low ceiling	Walls high ceiling	Columns low ceiling	Columns high ceiling	Low level	Ceilings threshold	Ceilings	Walls	Escalators	Ceiling low	Ceilings high	Walls	Low level	Ceilings	Ceiling Perimeter	Walls	Ceilings	Ceiling Perimeter	Walls	Ceilings	Platform edge doors	Walls	Platform edge	
Recessed downlights	•	•	•	•	•			•	•		•	•			•	•			•	•		•	•						
Recessed downlights large			•	•				•								•													
Surface mounted downlights			•					•								•													
Recessed wall washer		•	•	•	•							•			•	•			•	•		•							
Heritage surface mount downlights	•	•	•					•	•		•	•			•	•			•			•							
Ceiling recessed linear LED / fluorescent		•	•									•			•	•			•			•	•						
Ceiling mounted linear LED / fluorescent			•									•			•	•			•			•							
Ceiling concealed linear LED / fluorescent		•	•	•	•			•	•			•			•	•			•	•		•							
Wall mount downlight						•	•	•	•																				
Wall mount up and downlight							•		•																				
Wall recessed floor wash luminaire													•				•	•											
Handrail integrated luminaire									•				•					•											
Heritage uplighters							•		•				•																
Freize concealed linear LED / fluorescent						•	•					•					•				•						•		
Feature halo		•																											
Feature halo suspended			•																										
Feature pendants			•								•					•													
Heritage pendants		•	•								•					•													
Surface mounted spot light								•																		•	•		
Blue light LED linear luminaires																													•



## LED lighting

LED technology should be given preference over other types of luminaires and used wherever appropriate.

Constant advances in technology mean that luminaire and lamp selection requires detailed research, calculation and informed prediction of what will be achievable.

Important considerations when selecting LED lighting are:

- Colour rendering – how the quality of light affects the perception of colour
- Colour consistency – good colour rendering does not necessarily mean good colour consistency
- Quality of LED
- Quality of reflector
- Quality of driver
- Luminaire technical performance, Light Output Ratio (LOR), build quality and efficacy lm/W
- Lamp life
- Whole life cost
- Guarantees/warranties
- Zhaga modules – standardisation
- Future proofing



## Fibre optic lighting

Fibre optic lighting and associated projector luminaires can be a useful tool in the lighting designer's arsenal as they often provide lighting in inaccessible areas such as voids over escalators.

However, fibre optic lighting is comparatively inefficient (60 per cent at best and usually around 30-40 per cent efficient). Such systems work well in retail and display situations where eradication of heat from the light emitter is required or where feature is required (such as sparkle ceilings or water features).

Fibre optic lighting is not good for illuminating large areas as the quality of light is either extremely directional or very flat and ethereal. Also, lamp failure results in several light sources failing as often a single light projector powers several fibre optic 'heads'.

An interesting use for such illumination on the Underground is lighting placed in the side panels of escalators, washing the treads. Such lighting would allow the fibre optic projector to be located remotely from the escalator, making maintenance on the escalator lighting very easy (an escalator engineer would not be required).

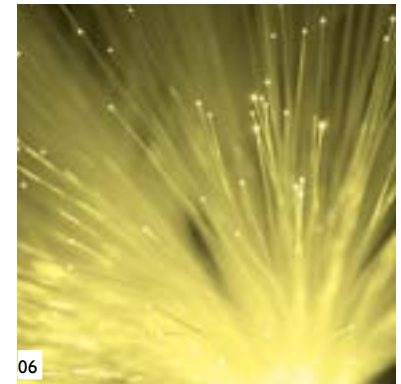
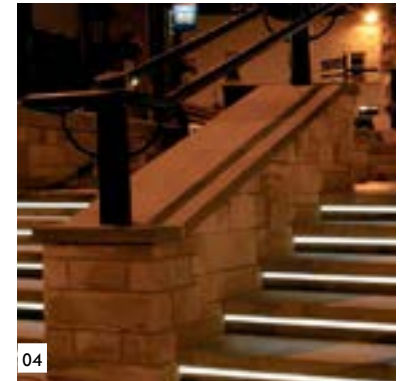

01-06  
Examples of stations using  
fibre optic and LED lighting





### Lighting

From 2015, certain lines will run a post-midnight service, bringing some routes on the network into 24-hour operation. Lighting will inevitably play a large role in the implementation and operation of the Night Tube and could be instrumental in the way station staff manage the flow of customers through the network as the services switch from day to night operations.

As parts of the Underground network have no access to natural light, the general illumination requirements within the network will remain the same. However, lighting could aid orientation and help to minimise any increase in energy usage associated with running the station 24 hours a day.



### Orientation

To help customers navigate the station at night, use lighting controls to enable the levels of illumination to be lowered in specific areas of the station. This could highlight routes leading to the Night Tube platforms, while discouraging the use of routes to lines not in service.

Use colour changing luminaires to aid orientation. Changing the lighting effects at the edge of walkways and tunnels could flag up routes that lead to the Night Tube platforms and those that will not. Red light at an entrance, for example, would indicate that this route is closed.



### Energy conservation

Use absence-linked dimming to save energy when there are fewer passengers during the night service.

## 7.19 Performance criteria

### The Underground requires energy-efficient and sustainable lighting design that has both longevity and maintainability.

It is therefore imperative that all light sources used are as efficient as possible. Follow these rules:

- Only luminaires with an LOR of greater than 80 per cent should be used. Luminaires with 100 per cent LOR should be treated with great care as many manufacturers quote the lumen output of the LED chip and do not consider losses via the luminaire
- An LOR of 100 per cent could be considered correct if the luminaire manufacturer is quoting a reduction of initial lamp/LED lumens. Such claims can only be corroborated if a comparison of data between the LED chip manufacturer and luminaire manufacturer is carried out
- It is a misconception that LED luminaires should be considered a 'one-piece' commodity luminaire, to be thrown away at the end of life. All luminaires should have replaceable light sources (LED and traditional lamp sources), as well as easily replaceable drivers/transformers/ballasts. The manufacturer should guarantee all equipment and technology for at least three years' service (with the exception of traditional lamp technology)
- LED technology is at the cutting edge of lighting development and can be subject to significant variances from LED chip manufacturer to manufacturer. Each lighting design is encouraged to minimise the number of LED chip manufacturers across a given space to avoid differences in efficacy, colour temperature, colour consistency and colour rendering
- Older lamp technologies are still acceptable to use as they still offer good energy savings and, in the case of Philips Ultra-Life T8 lamps, offer similar life expectancy to LED (and marginally better efficacy)
- Both linear and spotlight LED chips are inherently directional sources, so where a softer quality of illumination is required, fluorescent technology may be more appropriate
- The latest LED technology has a typical maximum lumen output of 5,000 lumens and still does not compete (or compare) with high-powered ceramic metal halide lamp sources above 50W. There may be opportunities for using such technologies, however, consideration should be given to 'warm-up and re-strike' times, as such lamps are not 'instant on' and are difficult to dim.

### Colour consistency and colour temperature

The colour temperature of a light source is conventionally stated in the unit of absolute temperature, in Degrees Kelvin (having the unit symbol K). Colour temperatures over 4,000K are called cool colours (bluish white), while lower colour temperatures 2,700K – 3,000K are called warmer colours (yellowish white, through red).

Where possible, the Underground's lighting should be of a warm white 3,000K to help create a welcoming environment.

### Colour rendering

CRI measures the ability of a light source to reveal the colours of various objects faithfully in comparison with an ideal or natural light source.

The CRI of any light source used on the Underground should not be less than Ra80.

### Colour consistency

Colour properties of lamps may change over the life of the lamp. To ensure good colour consistency, all LED luminaires and lamps should come with a guarantee of colour stability of no less than three years.



**Lighting is a key element of the Idiom and, when applied properly, can transform a station. Use layers of light to create spaces that are safe and functional but also create excitement and drama. Use light as a tool to make stations flow better.**

### **Important things to remember:**

- The importance of good lighting
- The lighting principles, which underpin the new approach
- Use layers of light to build depth and perform different functions
- Maximise the use of natural light
- Apply lighting so customers smoothly adjust from light to bright spaces







# 8.0

## Integrate products and services

Good design is not just about choosing the right materials and lighting, it also involves integrating the other products and services which make up the station.

All network furniture, fixtures and equipment – such as customer information, safety equipment, ticketing, poster frames, advertising, CCTV and signage – must be fully integrated into the station so there is clarity and coherence from platform to pavement and across the network.



## In this section:

- Key products and services in a typical station
- Placing products and services
- Customer information hierarchy
- Station entrances
- Ticket halls
- Escalators, stairs and lifts
- Routeways
- Platforms
- Case study: creating clarity in a ticket hall
  - King's Cross western ticket hall



# 8.1 Key products and services in a typical station

## Products and services are items which do not have a structural connection to the building itself.

Below are some typical products and services you find in a station.

➔ See TfL Standards for products and I-136 Amenities and Facilities for a comprehensive list

## Locating products and services

- Determine which items are the most prominent and which can be less visible
- Use the same trim material for all products and services throughout the station
- Spaces free from clutter are easier to understand and to navigate through

➔ See chapter 3.6 for more information

- Leave sufficient breathing space between different activities to clearly zone them
- Often, the leftover breathing space is as important as the space which is being filled (like the white space on a page, it is the breathing space which gives visual importance to the filled in space)

### Station identifiers



### Station name

Often the first thing that a customer sees from the street.



### Flag pole or totem

A flagpole, javelin or Legible London plinth, with integrated roundel, can be used to act as a focus and define the station entrance from the public realm.



### Customer information zone

Cluster customer information into clear zones, to include maps and key customer and journey information.

### Customer touch points

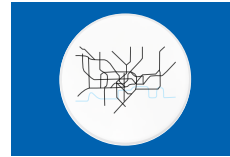

### Network and other maps

Whether in circular or rectangular frames, these should be placed in the most prominent areas of the space.

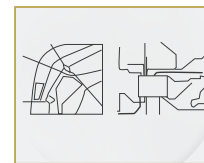

### Local information

Place close to station exits as well as outside the station.



### Ticket machine(s) and ticketing halo

Put near or in clear sight of network maps and customer information zones.

### Wayfinding



### Signage

A consistent approach to station signage, using New Johnston font, creates a sense of order and identity.

➔ See TfL Signs Manual for more information



### Combining signs

Where height may be a problem, the horizontal version as shown above will be more suitable.

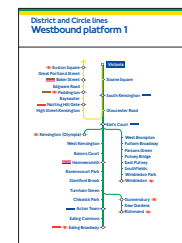

### Line diagram

Line diagrams should be positioned at or beyond bifurcation points, as an aid to journey planning.



## Furniture



### Seating

Benches should be placed at regular intervals throughout the station, especially where waiting opportunities arise.



### Staff seats

Locate these next to customer information zones and with maximum visibility to ticketing and the gateline.



### Bins

Place bins with equipment cabinets so they aren't too prominent and near platform exits and escalators.

## Safety and security



### Customer help point

Place these at key node points in the station, where customers can clearly see them and on the unpaid side of the ticket hall.



### Door signage

Too many signs can detract from the key information. Keep it concise by using the minimum amount needed.

## Safety and security



### Dome CCTV

Conceal CCTV where possible and house in the same material and colour as the surface they are mounted on.

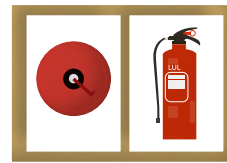

### Safety equipment cabinet

Combine all necessary safety items in one prominent place, making them easy for staff and customers to find.

## Commerce



### Retail kiosk

Kiosks should be convenient for customers, close to main flows but should not compete with customer messages.



### Cash machine

Cash machines are a great benefit to customers but should not compete with other key customer information.



### Advertising posters and frames (various sizes)

The space determines the type and positioning of advertising; as a rule, head-on is best.





## 8.2 Placing products and services

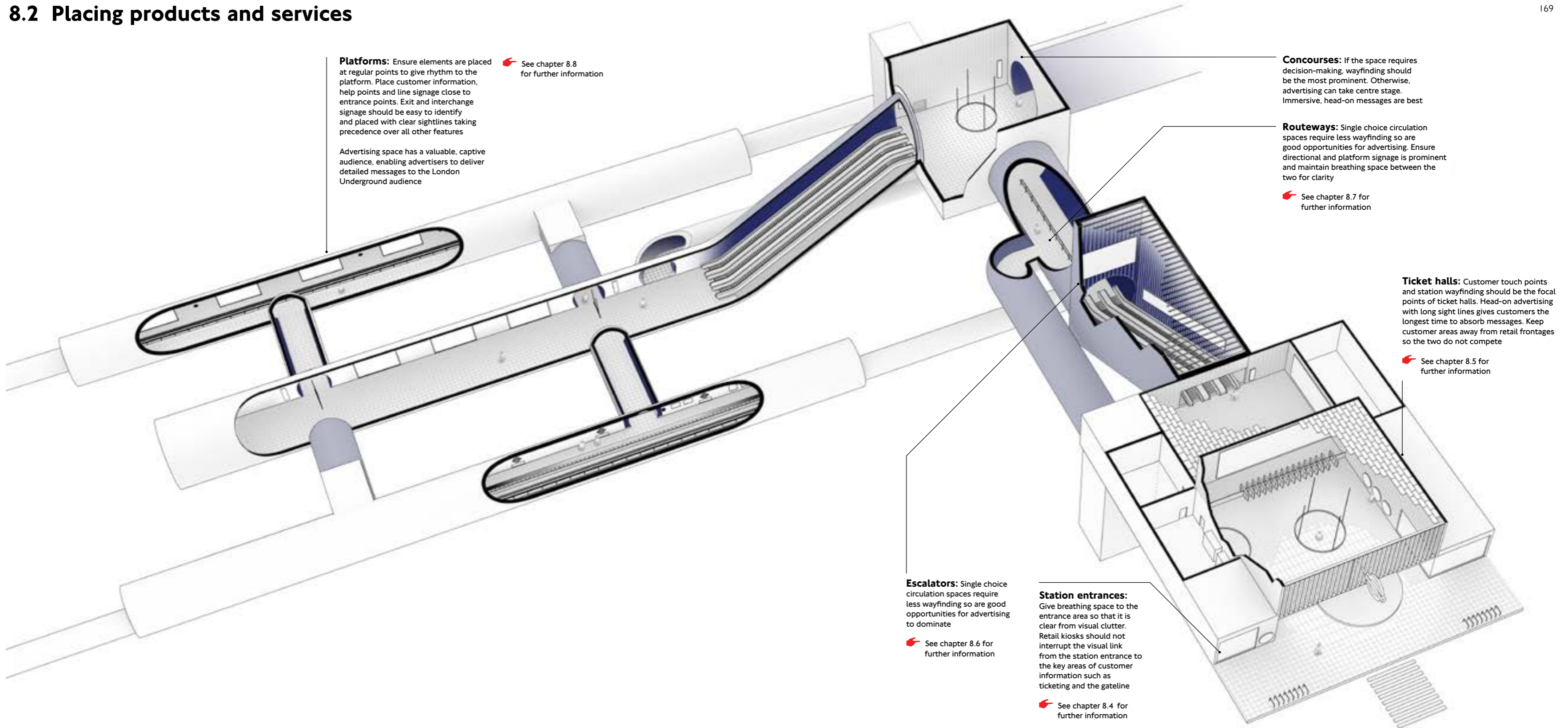

**Platforms:** Ensure elements are placed at regular points to give rhythm to the platform. Place customer information, help points and line signage close to entrance points. Exit and interchange signage should be easy to identify and placed with clear sightlines taking precedence over all other features

Advertising space has a valuable, captive audience, enabling advertisers to deliver detailed messages to the London Underground audience

See chapter 8.8 for further information

**Concourses:** If the space requires decision-making, wayfinding should be the most prominent. Otherwise, advertising can take centre stage. Immersive, head-on messages are best

**Routeways:** Single choice circulation spaces require less wayfinding so are good opportunities for advertising. Ensure directional and platform signage is prominent and maintain breathing space between the two for clarity

See chapter 8.7 for further information

**Ticket halls:** Customer touch points and station wayfinding should be the focal points of ticket halls. Head-on advertising with long sight lines gives customers the longest time to absorb messages. Keep customer areas away from retail frontages so the two do not compete

See chapter 8.5 for further information

**Escalators:** Single choice circulation spaces require less wayfinding so are good opportunities for advertising to dominate

See chapter 8.6 for further information

**Station entrances:** Give breathing space to the entrance area so that it is clear from visual clutter. Retail kiosks should not interrupt the visual link from the station entrance to the key areas of customer information such as ticketing and the gateline

See chapter 8.4 for further information

### **Information is vital in enabling customers to plan their journeys and move efficiently through the network.**

It is essential that customer information is displayed in dedicated, zoned areas throughout the station. However, in practice this can be difficult to achieve, especially in existing, constrained spaces.

The following information shows the most important information to include in each station area in order of importance as well as some guidance on where to locate it. This may vary depending on the station type, but in general the key pieces of information remain the same.

When placing circuit poster frames, be aware that there are a number of stakeholders who may require this space, including TfL Marketing, the London Transport Museum and the British Transport Police. When planning in an existing station, check who has existing poster frames and whether these need to be retained.

Poster frames should be centred, evenly spaced and visually balanced.

### **Station exteriors**

Information outside the station provides details of the services available at that station as well as information to assist customers to plan their journey if the station is closed. It should be located at each entrance and exit of the station. If there is no space available outside the station, this information should be located in the ticket hall where customers leaving the station can see it.

Information required:

1. Continuing your journey (QR poster)
2. Station services (QR or DR poster, depending on the number of lines serving the station)
3. Night bus map (DR poster, not required at all stations)
4. Circuit posters (DR). These should be used to provide visual balance
5. Rail and Tube map (QR). This should be provided if one is not available in the ticket hall



## Ticket Halls

The ticket hall is the most important area for journey planning so it is vital to zone information as much as possible. As a minimum, the leaflet rack and Tube map should be located together alongside a staff seat to create an Information Zone. If ticket halls are only used for entrance or exit, the information provided should be adjusted accordingly e.g. the 'Continuing your journey' poster is not required in an entry only ticket hall. Unless stated, all information should be located on the unpaid side.

Information required:

1. Leaflet Rack (DR)
2. Tube map/Rail and Tube map (QR). In Gateway and Destination stations this should be located within a white circle. If only one QR frame is available in the ticket hall, a Rail and Tube map should be provided if there is a rail interchange at the station; otherwise it should be a Tube map.

3. Continuing your journey (QR). Locate where customers leaving the station can see it.
4. Night Tube poster (QR or DR). The QR poster should be used at Gateway stations and those Destination stations where a high level of Night Tube use is expected. It should be located in the main information zone if possible. The poster is not required at stations which are not served by Night Tube.
5. Exploring the River (DR). Only required at stations with a direct interchange with a pier
6. Timetable information (DR). Only required at some Metropolitan line stations where there are longer gaps between trains
7. Planned engineering works. If not in information zone, locate near the gateline. This may be located on the paid side if there is no space on the unpaid side
8. Circuits. Use these to balance information zones
9. Fares list (DR or MFL). Locate as close to the POMs as possible

## Routeways and concourse areas

Customer information should be provided on interchange routes at key decision making points to provide reassurance to customers moving between lines. At stations with only one line, the only information required in these areas is the line diagram.

1. Tube map/Rail and Tube map (QR). Use the Rail and Tube map if there is a rail interchange within the station
2. Circuits. Use these to provide visual balance if required.

## Platforms

Information on platforms helps customers to understand how long their journey may take and to plan any interchanges that they need to make. It should be grouped into zones located near each platform entrance and exit.

Information required:

1. Station closed board. Required on sub surface platforms. Can incorporate Night Tube where required or Tube map
2. Timetable poster (DR)
3. Tube map (QR)
4. Rail and Tube map (QR). Provide in addition to Tube map when the station is a rail interchange.
5. Night Tube map (QR). Only required at stations served by Night Tube or those nearby
6. Heathrow terminal guide (DR). Only required at Piccadilly line stations
7. Circuits (DR). Use to provide visual balance to information zones and in dedicated areas spaced along the platform





Fix CCTV to the building or existing lamp columns and match the CCTV and column finishes

Add a border of the station trim material to the surround and reveals of the station entrance to highlight and frame its street presence

Place local information close to entrances and outside of the Bostwick gates, so that it can be accessed when the station is closed

Ensure there is breathing space around the station entrance of three metres. Place retail kiosks and newsstands outside of this zone

Tube stations that can only be accessed via a subway should be easy to find and use and be clearly recognisable as an Underground station





Locate cycle parking close to the entrance, without obstructing passenger flows

Place station services information close to entrances to help customers plan their journey

Integrate the station roundel into the design of the façade

Integrate lighting within the station canopy to create a glow of brighter light at the entrance

Totems should be placed in a clutter free space to allow customers to view information clearly

➔ See chapter 7.0 for further information

### Advertising in ticket halls

For an advertiser, the ticket hall is one of the most sought after parts of the station as it has the potential to deliver 100 per cent of traffic flow and usually good dwell times too.

The best locations for advertising are those that deliver head-on messages to customers, ideally with long sight-lines so messages have time to be absorbed.

Often the area with the highest impact for advertisers is also the most useful for essential customer information, so in such locations a balance must be struck. Where a prime spot can be found, and the station provides sufficiently high footfall, a digital display can be used. This maximises the number of advertisers that can be displayed in any given period.

Ticket gates offer further advertising opportunities and are available across all Underground stations. Carefully consider the type and quality of the advertisements in these areas to ensure they do not overly distract customers when entering or exiting a station.

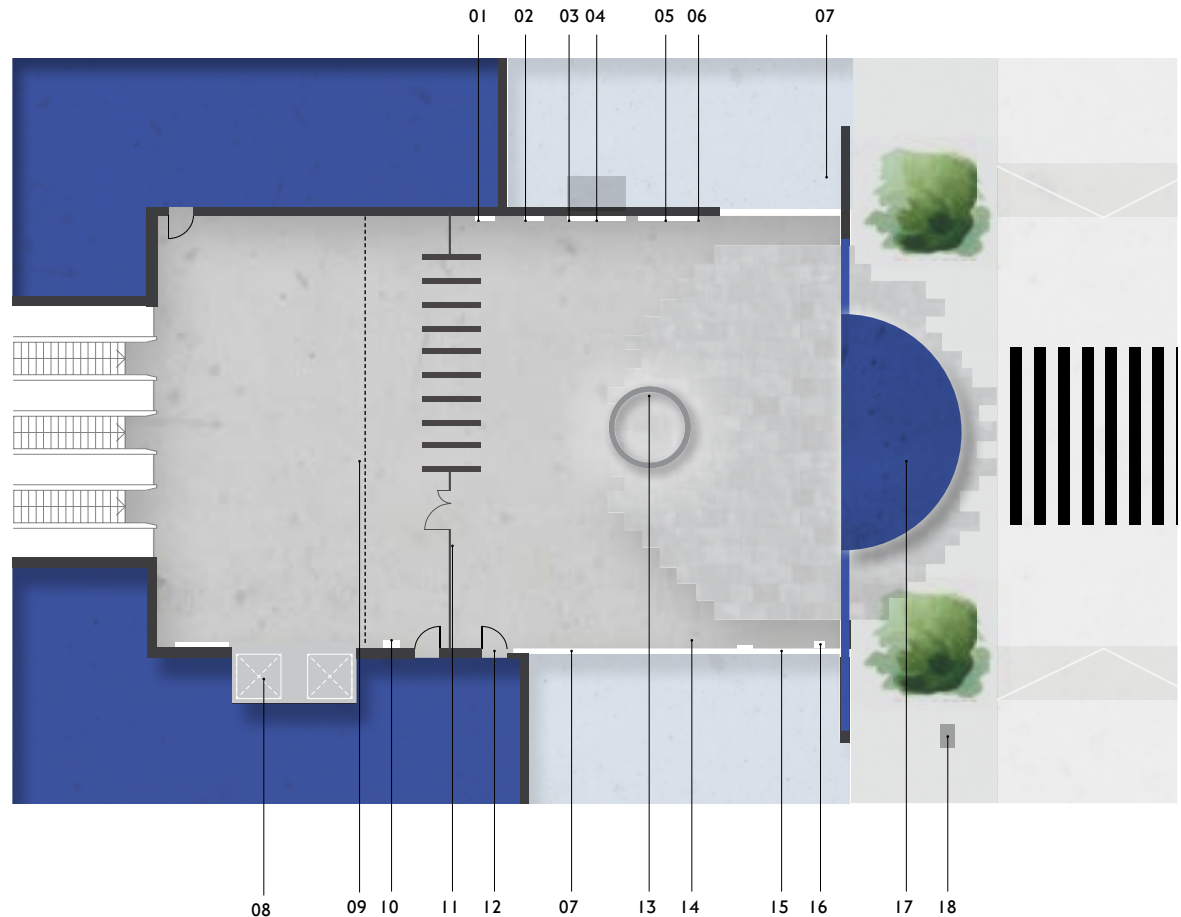

#### Typical items:

- |  |                                |
|--|--------------------------------|
| 01 Customer help point                     | 10 Safety equipment cabinet    |
| 02 Staff seat                              | 11 Gateline                    |
| 03 Leaflet rack                            | 12 Staff main entrance door    |
| 04 Network map                             | 13 Station feature halo        |
| 05 Local information                       | 14 Ticket machine(s) and halo  |
| 06 Wall mounted ESUB                       | 15 Cash machines               |
| 07 Retail unit                             | 16 Rubbish bin                 |
| 08 Step-free access                        | 17 Station canopy and mat well |
| 09 Advertising/poster frame above gateline | 18 Totem                       |

➔ See LU Standard S1371 Station Planning for more information



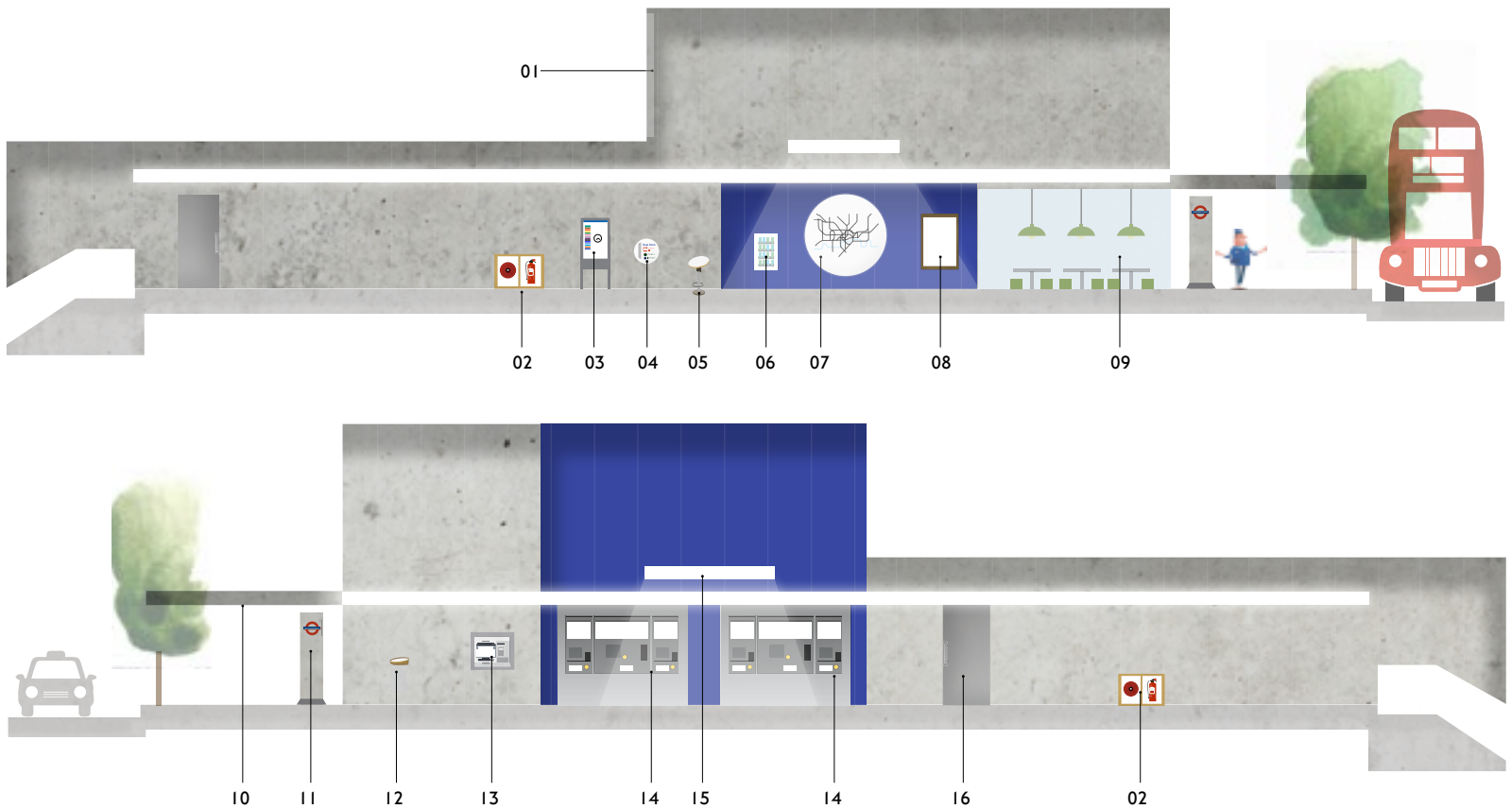

Well-designed ticket halls improve customer flows and journeys. Make the most of the sometimes limited space in a ticket hall to cater for orientation and information gathering, ticket purchases, easy transit to the platforms, congregation, shopping etc

When designing these spaces, ensure that you:

- Make customer information prominent and close to ticketing or within clear line of sight
- Place the feature halo at the nexus point of the ticket hall, with the clearest sight lines to ticketing, customer information and the gateline

- Place staff seating close to the customer information zone and within clear sight of the gateline and ticketing
- Cluster cash machines together and ensure there is breathing space between them and other areas of activity
- Install a built-in socket post system to help organise customers while they queue

#### Typical items:

- 01 Advertising/poster frame above gateline
- 02 Safety equipment cabinet
- 03 ESUB
- 04 Customer help point
- 05 Staff Seat
- 06 Leaflet rack
- 07 Network map
- 08 Poster frame
- 09 Retail unit
- 10 Station canopy
- 11 Totem
- 12 Rubbish bin
- 13 Cash machine
- 14 Ticket machine
- 15 Station feature halo
- 16 Staff main entrance door



## 8.6 Escalators, stairs and lifts

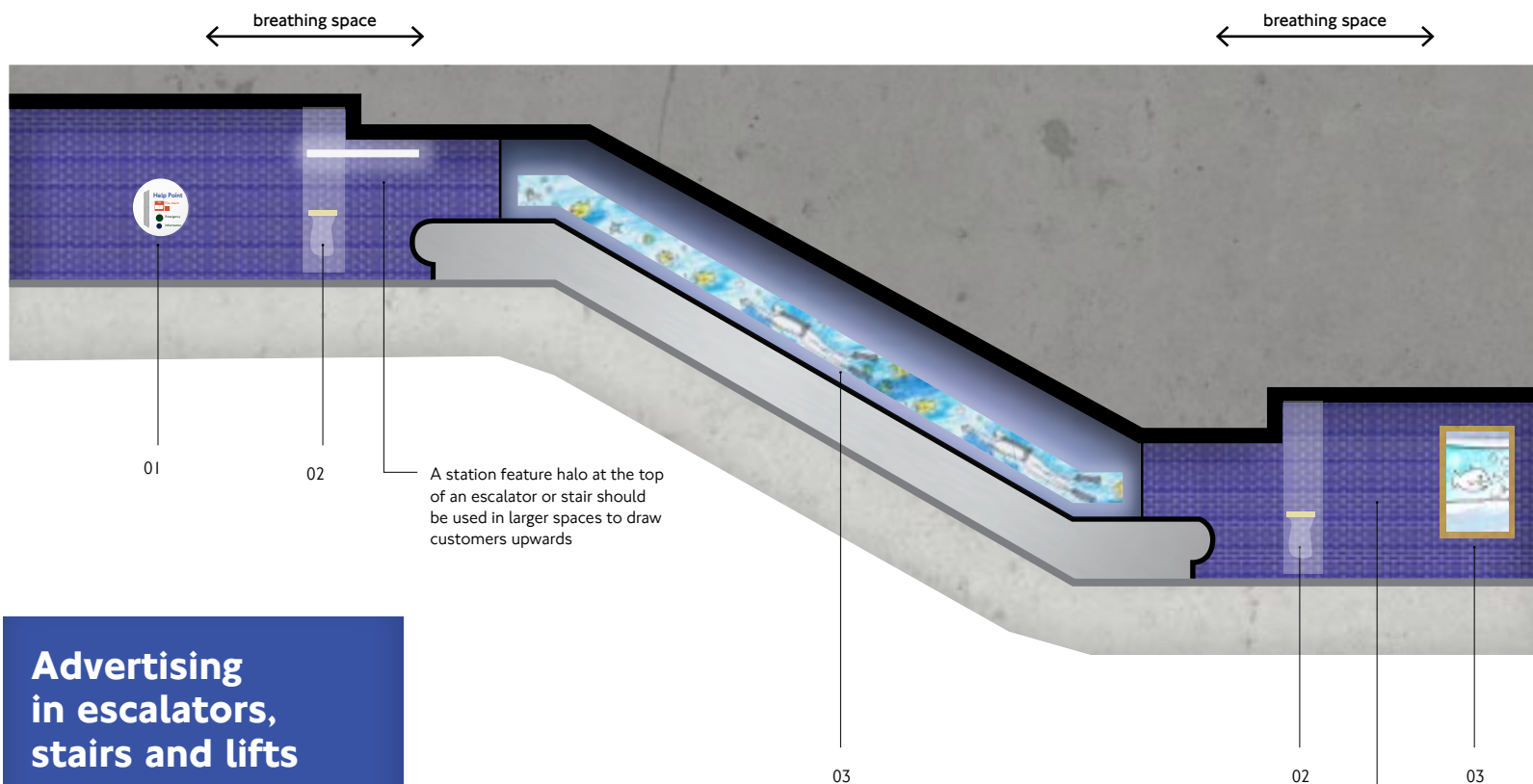

### Advertising in escalators, stairs and lifts

Escalators can provide advertisers with good dwell times to deliver smart, static advertising through the escalator panels, or interesting animated copy through the digital escalator panels – usually when they are leaving the station. The escalator arch is also sometimes used by advertisers wanting to create extra impact.

In larger spaces, use a station feature halo at the top of an escalator or stairs to draw customers upwards. Allow breathing space at the top and bottom of an escalator or stairway so passengers aren't distracted as they step on or off.

Allow breathing space at the top and bottom of an escalator or stair so as to not distract customers

#### Typical items:

- 01 Customer help point
- 02 Rubbish bin
- 03 Advertising





**Typical items:**

- 01 Customer seating
- 02 Advertising
- 03 Customer help point

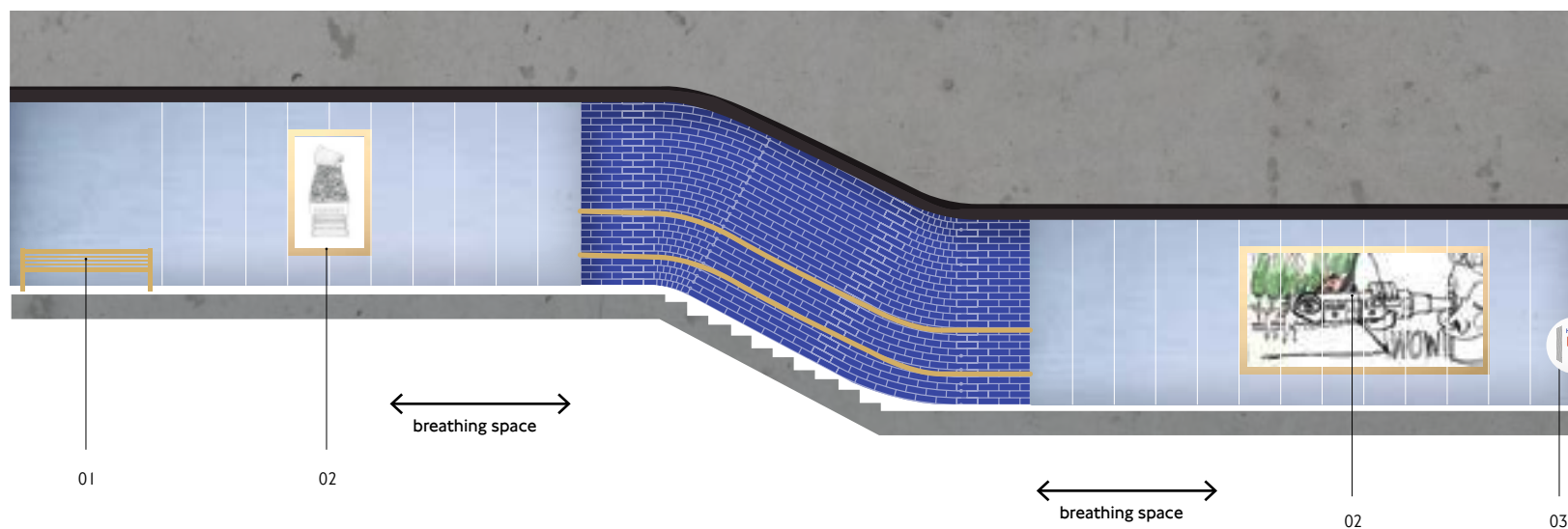

**Products and services in routeways:**

- Seating should be provided in long routeways if space allows
- Signage is the most important thing at decision points, and should be clearly visible at a distance. Signage has priority over advertising in these areas
- A tube map and help point should be provided at key decision points to assist customers

## Advertising in corridors and routeways

Corridors deliver lots of messages to the Underground audience at various points on their journey. This space requires simple messages, often delivered at high frequency levels, ensuring the audience can view and absorb the advertising message several times over the period of the campaign (usually two weeks).

The corridor space is often dominated by advertising, usually a combination of dry posted or glazed four sheets and 12 sheets, with illuminated six sheets or a digital display at the corridor turns. However, owing to the lack of dwell time, head-on locations and long sight lines, this area of the station delivers the lowest revenue returns on a like-for-like space basis.

In stations with wide aisles, for example Oxford Circus, a combination of fixed advertising assets, such as six sheets and digital displays can be found which, when combined with vinyl wrapped displays, can deliver a stunning result, dominating an entire area and creating true recognition for any advertiser.

# 8.8 Platforms

No two platforms are the same but there are key principles which apply to most locations. Above all, the elements on the platform should be balanced, regularly spaced and clearly identifiable. These are the steps to follow:

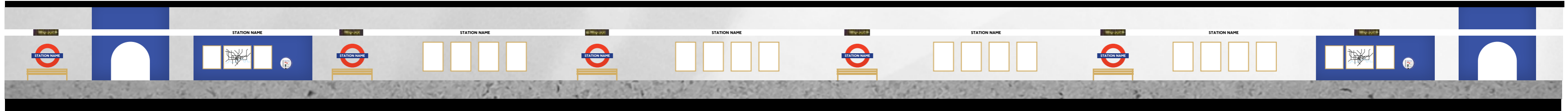

## 01. Fixed features

Identify the fixed features of the platform such as entrances, doorways or structural columns. These become the markers that determine the location of the other elements.

## 02. Roundels

Set the locations of the silhouette roundels – there should be eight/nine roundels on each platform, spaced as evenly as possible along the platform and between entrances.

## 03. Signage

Exit and interchange signage must take precedence in required positions, these being strengthened by the physical design of the space. Signage must have clear sightlines along the platform.

## 04. Seating

Once the settings of the roundels have been identified, locate the benches beneath them. Avoid arranging seating where the platform is narrow or busy.

## 05. Customer information

Place customer information as close to platform entrances as possible, condensed into zones. These zones should include a Tube map and timetable as a minimum. A Rail and Tube map should also be included if the station is a rail interchange. Allow 'breathing' space between this information and any adjacent signage or advertising. A station closed board is required on underground platforms (this is located behind a network map and opened out when needed).

## 06. Help points and safety equipment cabinets

Place help points evenly along the platform, with two help points close to customer information. Locate safety equipment cabinets at the ends and in the middle of the platform as required.

## 07. Advertising

Once the other elements of the platform have been established, set out the advertising in zones, allowing sufficient breathing space between any other items, ensuring there is a balanced approach. Advertising should be similarly spaced on both sides of the track to create a sense of balance where possible.

## Trackside



## 01. Line signage

Place line diagram signs close to, but not opposite, the platform entrances.

## 02. Roundels

Locate roundels opposite entrances and then space evenly along platform.

## 03. Advertising

Large format advertising should dominate the trackside and be spaced evenly, and (where possible) opposite platform side advertising. Ensure there is a regular and balanced layout to the trackside wall and balance with the platform side.



### Trackside side elevation

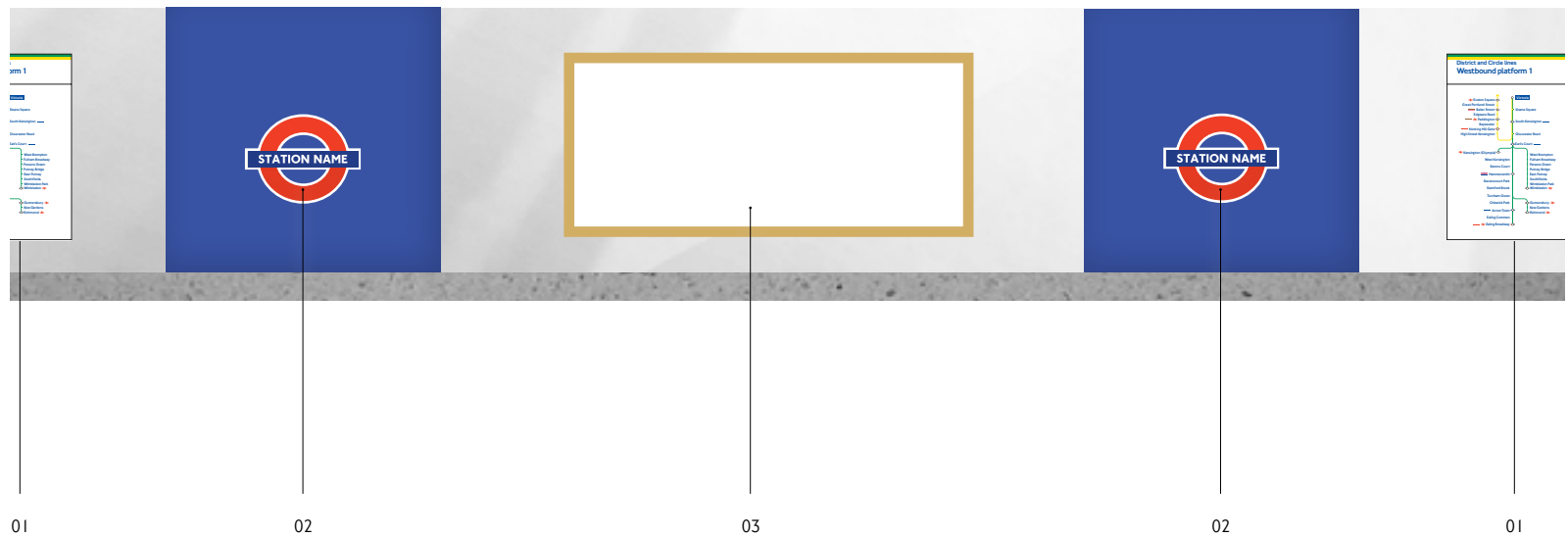

#### Typical items:

- 01 Line signage
- 02 Roundel
- 03 Advertising

## A note on advertising on platforms

The space available across the track is highly sought after. With an average dwell time of three minutes on a platform, it allows advertisers to deliver detailed messages to a captive Underground audience.

Passengers look to advertising to give them inspiration for 'books to read' or films to watch, and the platform environment is the perfect time in which to provide this information and distract from the daily commute.

Cross-track advertising assets usually consist of a combination of 16 sheets, 48 sheets and 96 sheets. Sometimes, the whole platform is given to one advertiser to dominate the space.

Cross-track projection is also available on some platforms across central London, delivering a combination of advertising messages and content.

The space available on the passenger side of the platform, visible to people waiting on the platform and those passing through on the Tube, is a combination of four sheets and 12 sheets.





## 8.9 Case study: creating clarity in a ticket hall

### - western ticket hall



**The original clarity of the King's Cross western ticket hall was confused by the arrangement of advertising, customer information and wayfinding on the long, single storey northern wall.**

The wall opposite the ticketing area is the prominent feature of the ticket hall when approached from all directions.

We clarified the space, adding order to the arrangement of the various products and services on the northern wall. We started by stripping the wall back to its original surface, then filled the dominant area opposite the gateline with a single high-impact advertising display (this replaced more ads that were in less prominent positions).

Above, is the wayfinding and line signage, pointing customers toward their onward Tube journey. To the left of the advertising and opposite the ticketing area, we installed a blue wall to clearly define the area for customer information and ticketing.

Lighting reflectors were added to subtly soften the ticket hall lighting and remove glare, while natural light is allowed to stream through revealed skywells. Lighting was placed over main areas, like ticketing, to highlight essential services. This made the hall feel clearer, more atmospheric and, most importantly, easier to use for staff and customers.



**Ensure you have the right station products and services to best serve the customer. Integrate these products and services carefully to create user-friendly environments, which are logically laid out and promote smooth customer flows.**

### **Important things to remember:**

- The key products and services that should exist in a typical station
- The best locations for these items, and zone them where appropriate
- The creation of clear and legible station entrances is vitally important
- The need to properly integrate network furniture and fixtures





# 9.0

## Prepare for the future

By embracing new technologies and understanding their benefits we can create better-designed stations that enhance the user experience.

This also means considering the life cycle of existing and new materials and products. Designing in flexibility allows our stations to better respond to new challenges, opportunities and change programmes.





## In this section:

- Designing for the whole life
- Life cycle costs
- Using standardised, off-site and modular systems
- Maintenance needs
- Emerging technologies
- Case study: the future of tickets halls
  - Oxford Circus



## Good design must consider the whole life. This means:

- Considering where the materials are sourced from
- Understanding how it will be decommissioned and all stages in between
- Seeing whether it has the potential for re-use and recycling
- Considering the cost
- Understanding how robust the material is; not everything has to last 150 years, as long as the proper replacement and maintenance regime is in place
- Understanding the environmental performance at all stages of the design's life cycle

## Follow these rules when selecting materials and products:

### Sourcing

Choosing materials and products that are sustainably sourced limits damage to the environment. Time is an important factor when sourcing; starting as early as possible extends choices and minimises costs.

### Manufacture/assembly

Consider how materials and products are transported, how this may affect lead-in times and how the manufacturing process could affect the future life of the products (for example, maintenance or replacement of batch items).

### Installation

Choose easy to install products, consider sequencing, access and the time taken to install.

### In-use

Consider the robustness of the material or product (including detailing). Choose materials that wear in rather than wear out. Materials that become more interesting and change positively with wear stay looking good for longer.

### Inspections

Will regular inspections be needed? If so, how often, and how will the area be accessed? If the inspections are more long term, will there need to be closures or temporary works installed for access?

### Regular cleaning

What is the cleaning regime? Is it a simple operation or will there need to be provision for specialist cleaning equipment and access? How does this affect the cost of regular cleaning?

### Repair

Are repairs easy to make, or does there need to be a full replacement? What are the access requirements to make a repair and how much will it cost?

### Replacement

Can replacement parts be easily sourced? Is the product or material from a single batch? If so, can the design incorporate an approach that makes replacement parts less noticeable? For example, the 2015 palette ceramic tiles include a deliberate degree of variation to make patch repair more viable.

### Decommissioning

How easily can the material or product be decommissioned? How will it be accessed and is it hazardous after a certain amount of time?

### Re-use

Can parts of the material or product be re-used, or recycled? What will happen to them after they have been used on the Underground?



## 9.2 Life cycle costs



**Consider the cost of the design proposal in terms of upfront costs, maintenance costs and costs to decommission.**

Once these costs have been understood, the most effective solution can be established, but remember to:

- Always favour long-term and long-lasting solutions
- Prioritise quality, especially with built environment materials
- Will this measure stand the test of time?
- Will the measure date or lose relevance to the public?
- Consider the long-term use and impact of the measure on staff and customers
- Favour modular solutions

**Standardised, modular and prefabricated components, constructed off-site, can have many benefits to station design, such as:**

- Programme savings
- Overall reduction in cost
- Improved quality
- Reconfigurable design opportunities
- Improved health, safety and environmental performance
- Improved sustainability
- Less disruption on site

### Incorporate into the design process as early as possible

### Materials

High-quality and durable finishes are achievable through factory controlled mixes, eg refurbishment of concrete by shot-blasting.

### Components

Use small-scale units that are manufactured offsite, eg precast concrete beams, wall slabs and columns.

### Subsystems

Use pre-assembled units which bring together multiple components offsite, eg most mechanical and engineering services, panelling, CMS, lighting columns and cladding systems.

### Systems

Use pre-assembled factory-finished units, installed within or on to a building or structure, eg lift shafts, footbridges, staircases and platforms.

### Buildings

Where possible use whole building construction off site in factories, eg train crew accommodation.





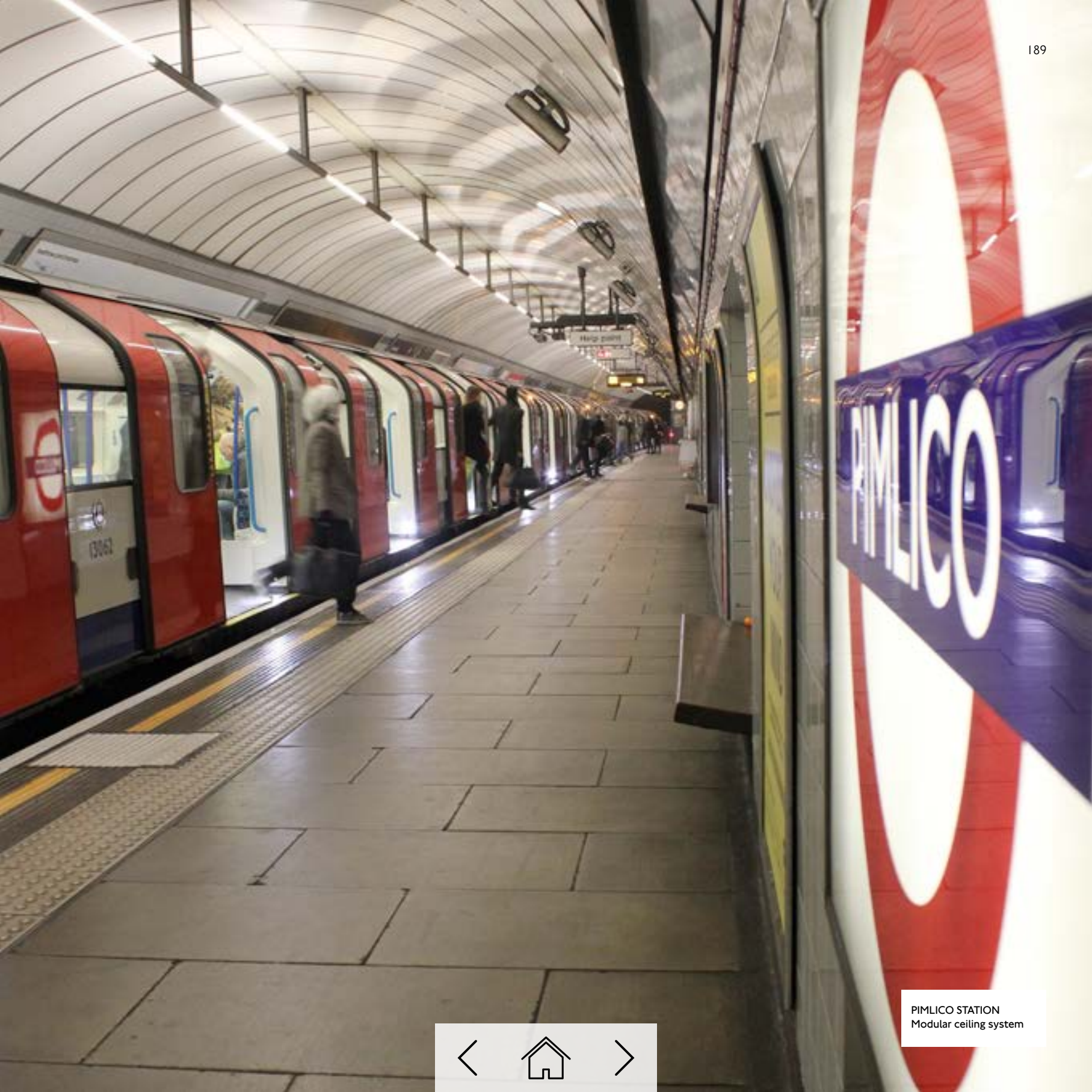

PIMLICO STATION  
Modular ceiling system



### Considering maintenance at the earliest stage in the design brings great benefits to projects.

Choose materials which:

- Maximise their life spans
- Are easy to clean, are easy to repair and replace

Follow the core principles to the right:



#### Involve specialists

Use specialists to gain a full understanding of a material's life cycle, robustness and 'cleanability'.

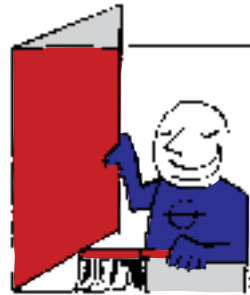

#### Make access easy

Ensure the access strategy is considered early with the maintainer in mind.

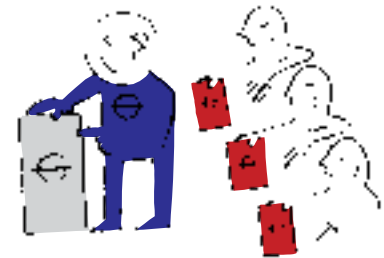

#### Make part replacement easy

Ensure parts are quick to source, easy to find and simple to reproduce or make if they are not 'off the shelf'.

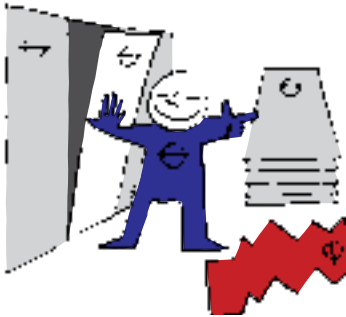

### Use modular systems

Use systems which can be easily plugged in and out. This often means a replacement can be installed while a repair is being carried out off-site – making the maintenance unnoticeable. Standard modules and panel sizes, rather than ‘specials’, make maintenance simpler.



### Make it durable

Make sure the material meets the toughest standards and is resistant to damage (whether accidental or malicious).



### Use protective coatings

Protective coatings, such as anti-fingerprint, scratch-resistant and anti-graffiti coatings, add to the life of the material. Consider aesthetic coatings, such as brushed finishes, which make marks less visible. Dark textured surfaces show less dirt and markings than bright flat ones.



### Make it easy to clean

Avoid shelves, difficult to access nooks and deep or thin ridges where dirt and dust can accumulate. Surfaces which can be quickly wiped down stay cleaner for longer. Choose materials which look good even when dirty.

## **The Underground is always exploring new technologies, with current developments in many fields of technology influencing the design of our of stations.**

When designing any station space:

- Consider the impact of these emerging technologies
- Design in flexibility
- Ensure there is a strategy for their inclusion in the future

## **Digital displays and interactive technology**

Current developments in interactive and touchscreen technologies will influence the design of stations. As information is condensed into interactive and changeable displays, customer messages will become less space-intensive and more adaptable. This will lead to clearer and more open spaces, especially in ticket halls and mean the servicing, maintenance and housing of these displays will need to be considered.

## **Advertising**

Digital technologies allow adverts to be combined with other customer messages, to make spaces work harder. The placement of advertising will be specifically picked for the quality of location, and in the future driven by a 'less is more' philosophy.

Ticket halls will include more large-format advertising to make use of the high level of wall space and create high-impact advertising locations. The merits of using these advertising assets, but with travel information displayed on each side, will be tested soon.

## **A wireless Underground**

Wireless technology allows staff and customers to connect more easily to the world above, to the internet and to one another. This means staff can access real-time information updates to pass on to customers, and customers can access more retail and advertising services while travelling. The design of stations needs to adapt to these changes by considering and incorporating the technology for wireless transmitters and device connections.

## **Escalators**

Video walls along the entire length of the escalators are planned; hopefully, sound, lighting and perhaps smell will also be available for a completely immersive sensory experience.

## **Lighting**

All new stations should be designed to have lighting controls. Lighting technology is becoming more efficient to run, requires less replacement and is more responsive to the changing needs of spaces. Beyond the environmental and cost benefits of this are the potential for adaptable and changeable spaces – triggered by their occupation or by external conditions; imagine a warmer colour of light when the sun is shining, for example.

## **Retail**

The retail market is changing radically, as technology pushes it toward short lease pop-ups, online retail and drop-off, and touch-screen vending. The design of stations needs to factor in these new types of trading, ensuring they are integrated early into the design and flexible enough to allow for changes.







01

## Materials

Advances in technology are making materials lighter, easier to install and more robust. Material coatings are also being developed that can give additional protection (such as vandal resistance) to materials.

It is vital these are incorporated into the Underground's approved materials list so their full potential can be harnessed.

## A 24-hour Underground for a 24-hour city

The 24-hour operation of the Underground has many operational issues and obvious benefits to customers. As a result, design needs to consider robustness, maintainability and access in even more depth, to ensure smooth operation is not hindered.

## Ticketing

With the introduction of Oyster cards and contactless payment, we are seeing a move away from the current system of ticketing which relies on exchanging our currency for that of the Underground. In future, we are likely to see this progressing into the use of mobile devices or apps that could remove the need for gatelines altogether, changing the way customers and staff move around ticket halls.

## Platform edge doors

With platform edge doors in place, we can reduce the amount of light on the platforms and highlight the key areas of customer information, routeways, advertising and signage.

01  
REGENT STREET  
Digital signage providing real  
time information



## 9.6 Case study: the future of ticket halls - Oxford Circus



**The Oxford Circus of the future will be one free of clutter, opened up to its original 'circus' form and with integrated retail and advertising.**

There will no longer be a gateline, which means customers can travel more freely through the ticket hall.

We started by stripping the ticket hall back to essential information and removing clutter and anything which impeded the original circular form of the ticket hall. Following the principle that 'place should begin at platform', Oxford Circus will offer an immersive digital, often branded and tailored experience.

The station will be opened up to reveal its perfectly circular form; a halo of natural light will be filtered in; branding and art will decorate the walls and ceilings, and a digital and changeable 3D experience will be created for both customer information and commercial opportunities.

With the fundamental structure revealed, the focus can shift to making the station perform better. Connectivity will be expanded at ground level (respecting the character and fabric of the two Grade II listed surface buildings) and the underground spaces made to flow, with connections to Argyll Street, Regent Street and further east and west on Oxford Street.



**Customer expectations evolve rapidly and our stations must change to meet these needs. Remember to design stations with durability and flexibility in mind. Understand future maintenance needs and consider whole-life costs upfront.**

### **Important things to remember:**

- Design in flexibility to adapt to change programmes and emerging technologies
- Consider the whole-life costs before selecting a product or material
- Design in maintenance requirements from the beginning
- The perfect station of the future!



## **The Idiom is only the start of our journey towards delivering great design on the Underground.**

As we begin to apply these principles to our projects, there is still more we can do to ensure our staff and customer environments are both functional and enjoyable spaces.

In order to deliver the Idiom effectively, we need to develop further items to support it, in particular a range of new products to meet the needs of our customers. Some of these, such as ticket hall halos, are already being designed, while others, including canopies and welcoming mats at the station entrance, are yet to be created. And there remains work to do to try to improve the way we locate and install other items, such as fire equipment, on our stations.

Some areas, such as acoustics in stations, are yet to be investigated. This could potentially have a huge positive impact on our customers' ability to hear information and announcements. As the Idiom begins to be used more widely, other questions may arise which need to be incorporated into the document. And, inevitably, as technology develops, new design opportunities which have not been considered here may become available.

We will also be working to extend these principles to London Overground and DLR stations, which will give our customers a more consistent experience as they travel across TfL services.

This means that, to a certain extent, the Idiom will be a living document. However, despite the changes and developments that the future may bring, it will continue to uphold the principles of great design throughout all of our stations.







STAY COOL  
RIDE THE UNDERGROUND



# 10.0

## Flashcards

The Idiom Flashcards contain the colour scheme, materials and special features for each design type. They should be used as a visual guide when doing any works to a station.



# 10.01 Network station design type map

## Network station design type

- 10.01 Central London Railway
- 10.02 Clarke (City)
- 10.03 Clarke (Suburban)
- 10.04 District Victorian
- 10.05 Great Eastern
- 10.06 Great Northern
- 10.07 Great Western
- 10.08 Heaps (Early)
- 10.09 Heaps (Later)
- 10.10 Holden (Northern Style)
- 10.11 Holden (Picadilly Style)
- 10.12 JLE Style
- 10.13 Late 1970s
- 10.14 Leslie Green
- 10.15 London, Midland and Scottish Railway (Upminster)
- 10.16 Metropolitan Victorian
- 10.17 New Works (Pre WWII and Post WWII)
- 10.18 Victoria Line Style
- 10.19 Whitechapel and Bow, LTSR and LNWR
- 10.20 2015 Palette
- Network Rail

## Heritage

- Listed Structures
- Locally Listings
- Conservation Areas

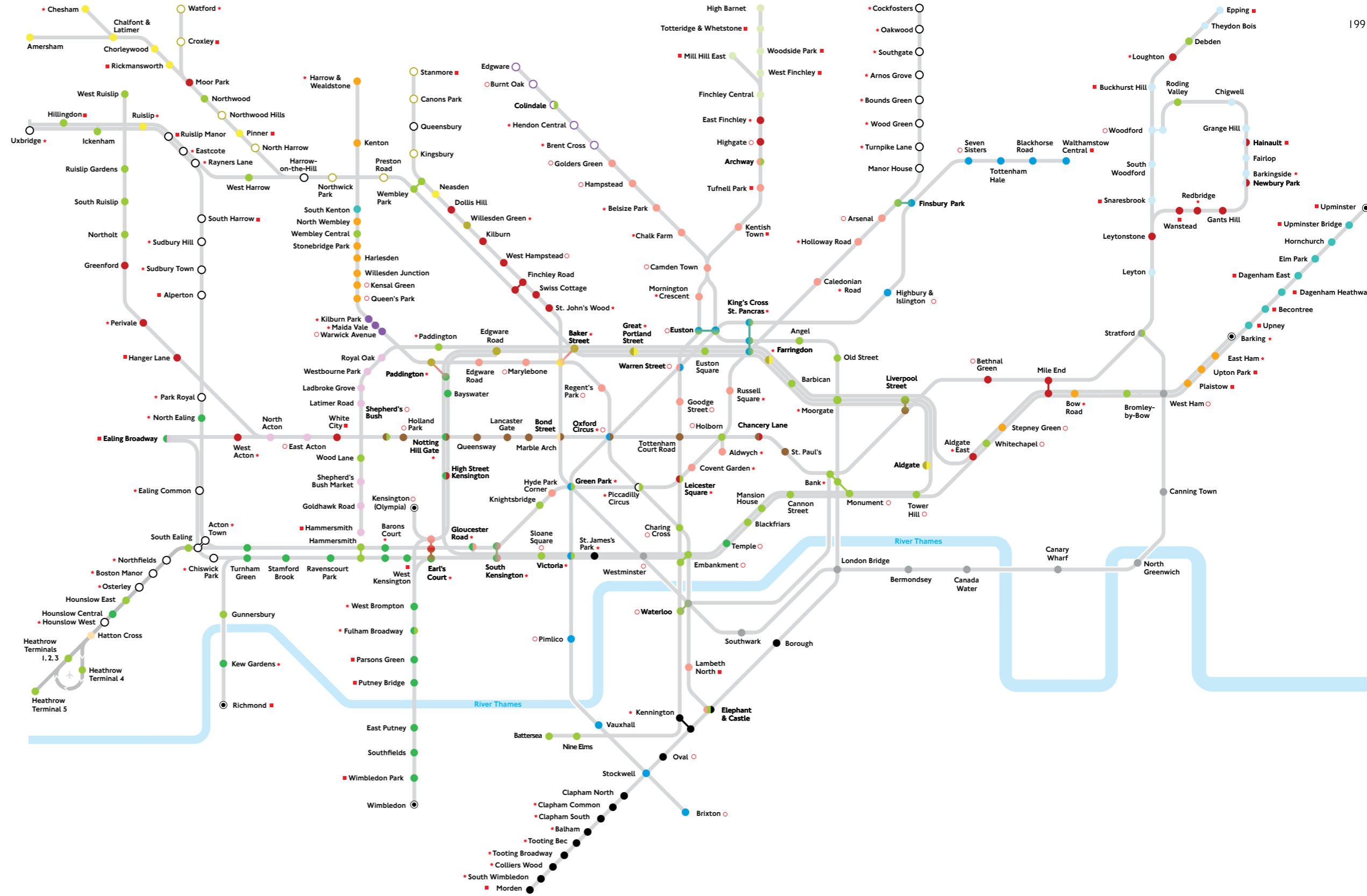

# 10.02 Central London Railway

**Central London Railway** – Stations originally designed by architect Harry Bell Measures. Only a few surface faience buildings survived but the plain white tiled platforms have been progressively reintroduced.

## Stations

- Bond Street (ticket hall, routeways and Central line platforms)
- Chancery Lane (excluding entrances)
- Holland Park
- Lancaster Gate
- Liverpool Street (Central line platforms)
- Marble Arch
- Notting Hill Gate
- Oxford Circus (excluding Victoria platforms)
- Queensway
- Shepherd's Bush (platforms)
- St. Paul's
- Tottenham Court Road (excluding murals)

## Colour

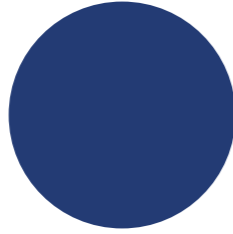

Blue  
NCS-S 4550-R80B

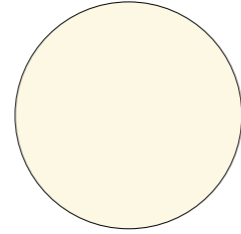

Biscuit  
NCS-S 0804-G90Y

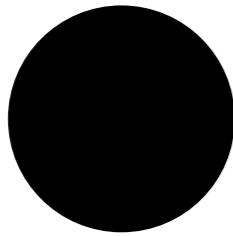

Black  
NCS-S 9000-N



Trim colour  
Bronze finished brushed stainless steel

## Materiality

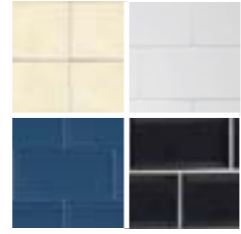

Ceramic  
White (plat)/biscuit (th)/  
black (plat/th)/blue (plat)

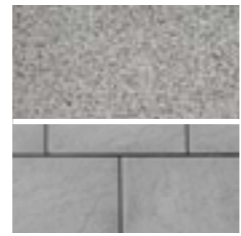

Floor tiles/pavers  
Grey granite  
Concrete flagstone

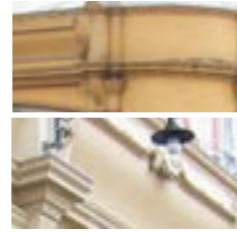

Terracotta faience (Holland Park)/  
Painted terracotta faience (Queensway)

## Special features



Exterior terracotta faience (Holland Park)



Clr platform clock (Lancaster Gate)



External wall mounted light (Queensway)



Wall mounted info-board (Holland Park)

## Examples stations



Holland Park exterior



Oxford Circus exterior



Notting Hill Gate platform



Shepherd's Bush platform



# 10.03 Clarke (City)

**Clarke (City)** – During the 1920s and 30s many of the Metropolitan’s original 1860s and 70s stations were rebuilt to Charles Clarke’s designs. These make extensive use of the ‘marble white’ faience exteriors.

## Stations

- Aldgate (surface building)
- Baker Street (Metropolitan line)
- Edgware Road (D&C)
- Farringdon (entrance, main ticket hall)
- Great Portland Street (station building)
- Paddington (facade only, D&C)
- Willesden Green

## Colour

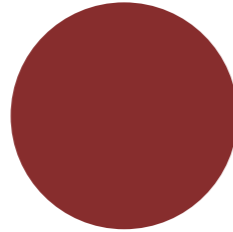

Maroon  
NCS-S 5040R

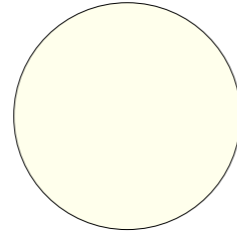

Light Cream  
NCS-S 0605-Y26R

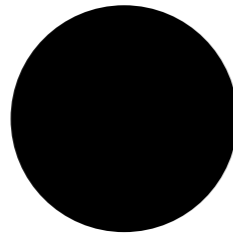

Black  
NCS-S 9000-N

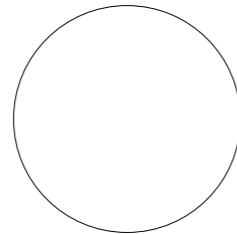

White  
NCS-S 0500-N



Trim Colour  
Bronze finished brushed  
Stainless steel

## Materiality



‘Marble’ faience  
White marble (ext)

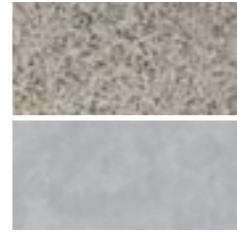

Floor tiles/Pavers  
Grey granite (int)  
Concrete Paving (ext)



Brick  
London stock (plat)



Tiled panels  
Willesden Green (tiles int)



Cast iron  
Canopy supports (plat)  
(Willesden Green)



Vitreous Enamel tiles (Great  
Portland Street)



Timber  
Painted valance (plat)  
(Willesden Green)

## Special features



Clock and iron work  
(Aldgate)



Original style Coffe Beams and Coving (baker Street)



Decorative brackets  
(Willesden Green)



Lettering (Farringdon)



Clock (Willesden Green)



Entrance canopy (Aldgate)

## Examples stations



Willesden Green Exterior



Great Portland Street exterior



Willesden Green ticket hall



Willesden Green platform



# 10.04 Clarke (Suburban)

**Clarke (Suburban)** – These stations are illustrative of the 1920s and 30s expansion of the Metropolitan Railway which helped create new suburbs. These homely brick built stations echo contemporary housing and were designed by Metropolitan Railway architect Charles Clarke.

## Stations

- Canons Park
- Croxley
- Kingsbury
- North Harrow
- Northwick Park
- Northwood Hills
- Preston Road
- Stanmore
- Watford

## Colour

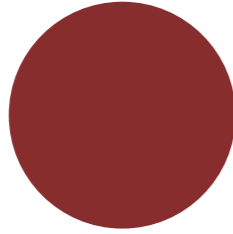

Maroon  
NCS-S 5040R

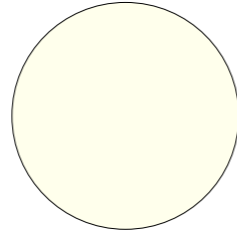

Light Cream  
NCS S 0605-Y26R

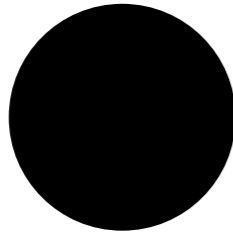

Black  
NCS-S 9000-N

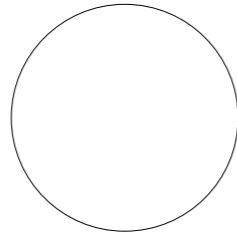

White  
NCS-S 0500-N



Trim Colour  
Bronze Finished Brushed  
Stainless Steel

## Materiality

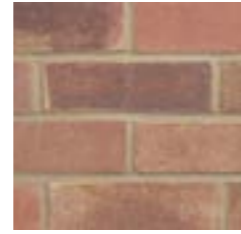

Brick

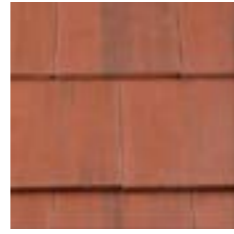

Clay  
Pitched roof tiles



Clay  
Red hanging roof tiles

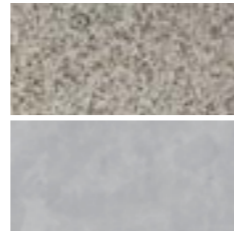

Floor tiles/pavers  
Grey granite (int)  
Concrete paving (ext)



Timber  
Painted sills/  
window frames (Croxley)



Steel  
Canopy supports (plat)  
(Watford)

## Special features



Pitched roof with chimney and sash windows  
(Croxley)



Inverted pitched platform canopy  
(Watford)



Timber dado (Kingsbury;th)



Glass tiling  
(Watford;th)

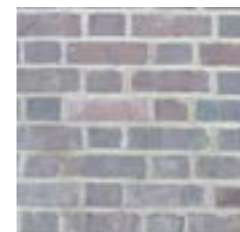

Brick construction  
Flemish bond  
(station specific)



Twin doric columns  
(Croxley)

## Examples stations



Croxley exterior

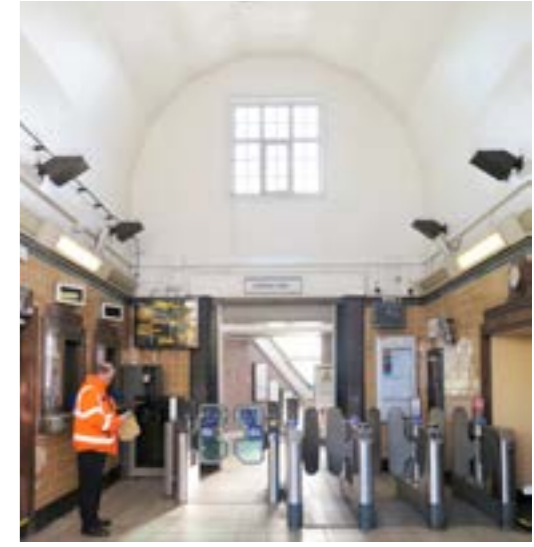

Kingsbury ticket hall



Kingsbury  
Modern sfa lift



Watford platform



# 10.05 District Victorian

**District/London and South Western Railway (Victorian)** – These stations were introduced during the Victorian and Edwardian expansion of the suburban west London lines. They were driven by the development of the District Railway and the mainline London and South Western Railway. London Underground eventually took over the stations from Hammersmith to Richmond and Wimbledon.

## Stations

- Barons Court
- Bayswater
- Ealing Broadway (District line train shed)
- Earls Court (train shed)
- East Putney
- Fulham Broadway (train shed)
- Gloucester Road (ticket hall and District platforms)
- High Street Kensington (platforms)
- Hounslow Central
- Kew Gardens
- North Ealing
- Notting Hill Gate (District line platform)
- Paddington (District line platforms)
- Parsons Green
- Putney Bridge
- Ravenscourt Park
- Southfields
- South Kensington (Ticket hall & District platforms)
- Stamford Brook
- Temple
- Turnham Green
- West Brompton
- West Kensington
- Wimbledon Park

## Colour

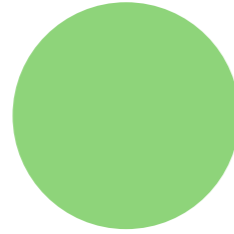

Light Green  
NCS-S 3040-G40Y

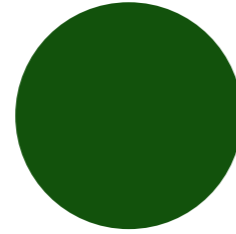

Dark Green  
NCS-S 6030-G10Y

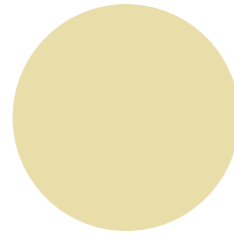

Pale Cream  
NCS-S 1030-Y10R

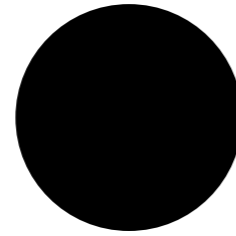

Black  
NCS-S 9000-N

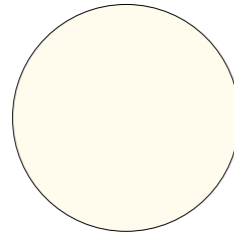

White  
NCS 0502-Y



Trim colour  
Bronze finished brushed stainless steel

## Materiality

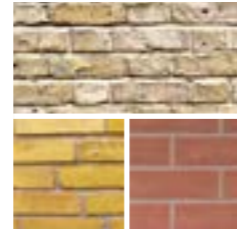

Brick  
London stock/yellow/red



Slate  
Roof tiles



Timber  
Painted cills/window frames/  
external architrave

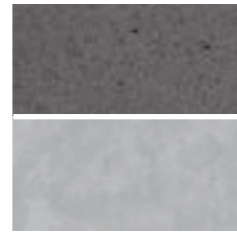

Floor tiles/pavers  
Grey granite/terrazzo (int)  
Mid grey concrete pavers (ext)



Cast iron  
Canopy supports (plat)



Timber  
Canopy supports (plat)



Timber  
Painted valance (plat)

## Special features



Roof trusses and framework (Ealing Broadway)

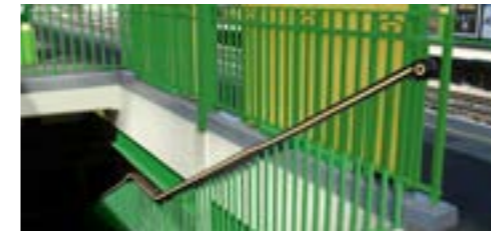

Balustrade, railings and steel beams (Ravenscourt Park)

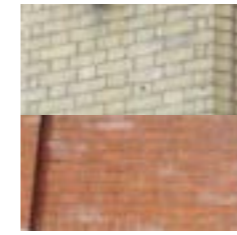

Brick construction  
Flemish bond / English  
bond (station specific)



Globe pendants  
(Notting Hill Gate)



Polychromatic arched  
entrance (East Putney)

## Examples stations



North Ealing exterior



Ravenscourt Park exterior



Turnham Green  
painted timber platform screens.



Ravenscourt Park  
Painted timber platform canopies



Notting Hill Gate  
Cast iron painted arch and glazed roof



**Great Eastern Railway** – These suburban line stations date from the period 1856 to 1903. Mostly yellow stock brick buildings and often showing much of their rural origins they became London Underground stations from 1947 to 1949.

## Stations

- Barkingside
- Buckhurst Hill
- Chigwell
- Epping
- Fairlop
- Grange Hill
- Hainault (platforms)
- Leyton
- Newbury Park (platforms)
- Snaresbrook
- South Woodford
- Theydon Bois
- Woodford

## Colour

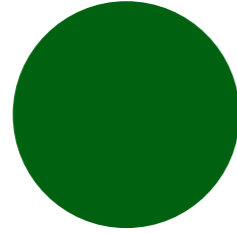

Light Brunswick Green  
NCS S 5540-G30Y

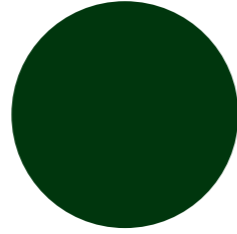

Dark Brunswick Green  
NCS S 8010-G10Y

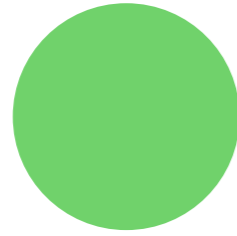

Sea Green  
NCS S 3040-G40Y

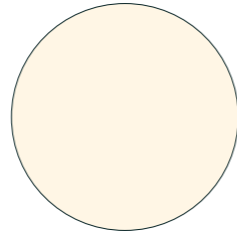

Light Cream  
NCS S 0605-Y26R

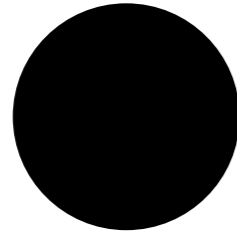

Black  
NCS S 9000-N

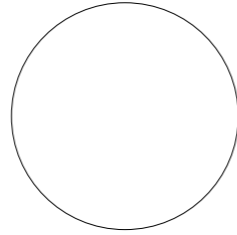

White  
NCS S 0500-N



Trim Colour  
Bronze Finished Brushed  
Stainless Steel

## Materiality



Cream painted plaster  
(Interior ticket hall/ subway stairs)

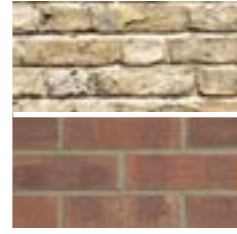

Brick  
London stock/red



Timber  
Painted panels/  
Dados/window frames



Slate  
Roof tiles



Floor tiles/pavers  
Grey granite  
Concrete slabs



Cast iron  
Canopy supports (plat)

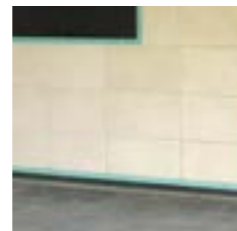

Ceramic tiles with  
Black contrast  
(Heavy wear areas)



Timber  
Painted pailing fences/  
valance (plat)

## Special features



Decorative brackets (Snaresbrook)



Lattice bridge details (Barkingside)



GER benches (Woodford)



Clock (Barkingside)



Windows and timber doors  
(Barkingside)

## Examples stations



Barkingside  
Red brick with stone corner details and clay roof tiles



Snaresbrook  
London stock brick façade with buff brick window and door surrounds



Snaresbrook  
Platform painted colour scheme with painted timber canopy



**Great Northern Railway** – These are Victorian brick built stations dating from the 1870s and transferred to London Underground in 1940.

## Stations

- Finchley Central
- High Barnet
- Mill Hill East
- Totteridge & Whetstone
- West Finchley
- Woodside Park

## Colour

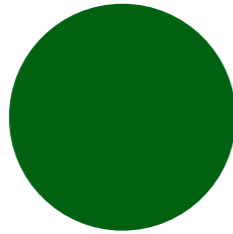

Light Brunswick Green  
NCS S 5540-G30Y

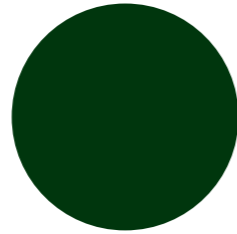

Dark Brunswick Green  
NCS S 8010-G10Y

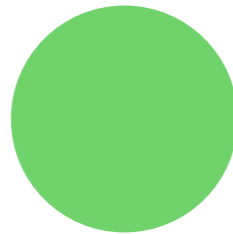

Sea Green  
NCS S 3040-G40Y

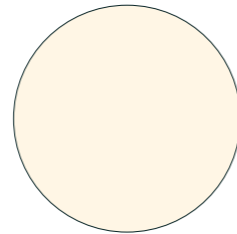

Light Cream  
NCS S 0605-Y26R

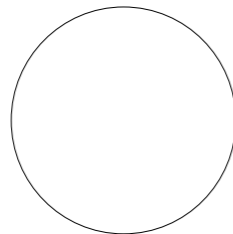

White  
NCS-S 0500-N

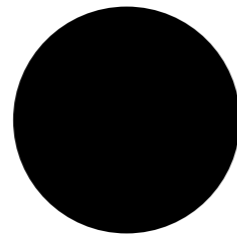

Black  
NCS-S 9000-N



Trim Colour  
Bronze Finished Brushed  
Stainless Steel

## Materiality

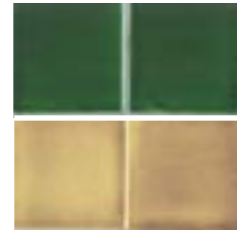

Ceramic  
Green/Cream Colour Wall  
Details/Panels



Brick  
London Stock



Timber  
Painted Panels /  
Dados / Window Frames



Slate  
Roof Tiles

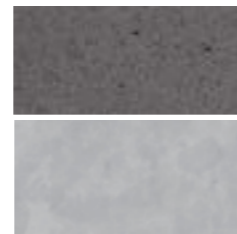

Floor tiles/pavers  
Grey granite/terrazzo (int)  
Mid grey concrete pavers (ext)



Cast Iron  
Canopy Supports (Plat)

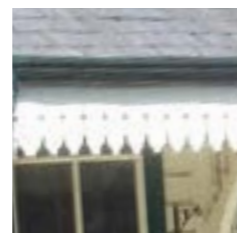

Timber  
Painted Pailing Fences/  
Valance (Plat)

## Special features



Decorative brackets  
(High Barnet)



Lattice bridge details  
(West Finchley)



Brick Construction  
Flemish Bond/English Bond  
(station specific)



Wall Details  
Timber Dado/Plaster/  
Tiled Details  
(Finchley Central)

## Examples stations



Woodside Park  
Painted timber and London stock brick ancillary building  
displaying the details and approach to colour composition



Woodside Park  
Stock brick station exterior with painted white window frames and  
dark brunswick green sills and doors. Slate pitched roof



West Finchley  
Timber clad platform building with timber and canopy and  
slate roof



High Barnet  
Cast iron platform canopy painted in station colours



West Finchley  
Waiting room interior showing cream and green  
painted timber walls



Woodside Park platform and platform building  
London stock brick platform with cast iron  
and timber canopy



**Great Western Railway (GWR)** – These are Victorian and Edwardian rebuilds of earlier stations, typical of the brick built style seen elsewhere on the old GWR lines.

## Stations

- Ealing Broadway (Central line platforms)
- East Acton
- Goldhawk Road
- Hammersmith (Hammersmith & Circle line)
- Ladbroke Grove
- Latimer Road
- North Acton
- Royal Oak
- Shepherd's Bush Market
- Westbourne Park

## Colour

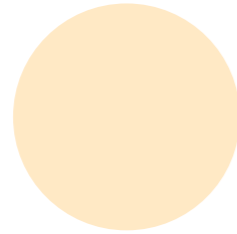

Biscuit  
NCS-S 1020-Y30R

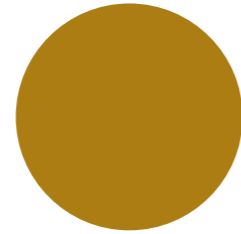

Golden brown  
NCS-S 4050-Y30R

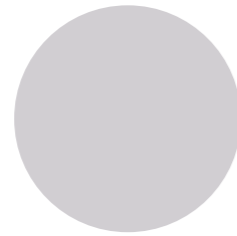

Light grey  
NCS-S 2500N

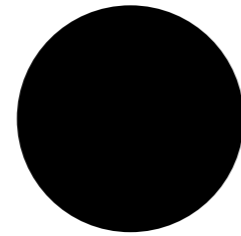

Black  
NCS-S 9000-N

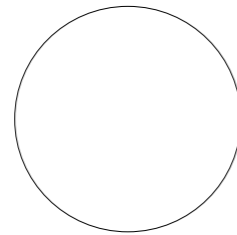

White  
NCS-S 0500-N



Trim colour  
Bronze finished brushed stainless steel

## Materiality

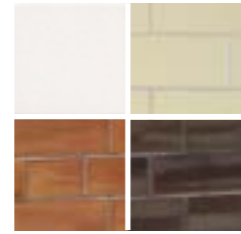

Ceramic  
White/cream/salt glazed brown/dark blue



Brick  
Buff/red



Timber  
Painted panels/  
Dados/window frames

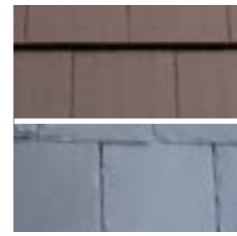

Slate  
Roof tiles

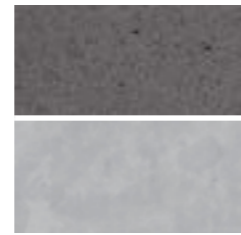

Floor tiles/pavers  
Grey granite/terrazzo (int)  
Mid grey concrete pavers (ext)



Cast iron  
Canopy supports (plat)



Timber  
Painted valance (plat)

## Special features



Decorative brackets  
(Royal Oak)



Lattice bridge details  
(Latimer Road)

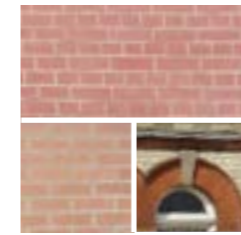

Brick construction  
English bond / stretcher bond / decorative bond (station specific)



Great western railway benches  
(Hammersmith H&C)

## Examples stations



East Acton



Hammersmith (H&C)



Westbourne Park  
Painted columns and platform walls in station colour scheme



Ladbroke Grove  
Brick platform walls and painted timber canopy detail



North Acton  
Painted metalwork footbridge in station colours



Ealing Broadway (Central line platforms)  
Painted canopy island platform in station colours



# 10.09 Heaps (early)

**Heaps (Early)** – Opened during the First World War and designed by Stanley Heaps, the Underground’s architect. These stations echo the earlier Leslie Green style in many ways.

## Stations

Kilburn Park  
Maida Vale  
Warwick Avenue

## Colour

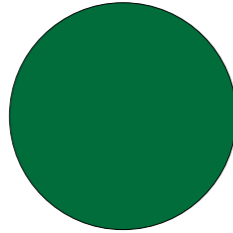

Flat bottle green  
NCS-S 4550-G10Y

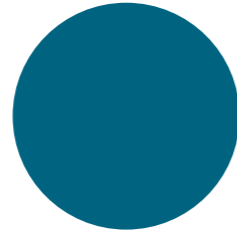

Flat blue  
NCS-S 4550-R90B

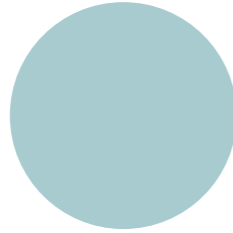

Ribbon blue  
NCS-S 2030-B10G

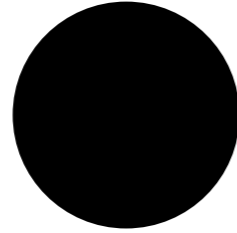

Black  
NCS-S 9000-N

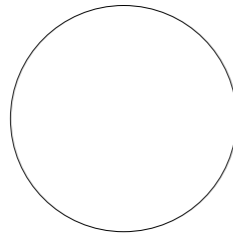

White  
NCS-S 0500-N



Trim colour  
Bronze finished brushed stainless steel

## Materiality



Glazed oxblood faience terracotta  
Wall details (ext)



Ceramic  
White / bottle green  
Wall details (int)



Painted plaster portal frame. Bottle green  
(Warwick Avenue)



Floor tiles  
Terrazzo (int)



Painted handrails



Varnished timber  
(Warwick Avenue; route ways)

## Special features



Glazed oxblood faience, terracotta facade with arch windows, exterior wall mounted light and original underground sign



Portal edge detail  
(Warwick Avenue)



Internal station clock  
(Maida Vale)



Original mosaic detail  
(Maida Vale)



Green and white checkered ceramic  
(Warwick Avenue)

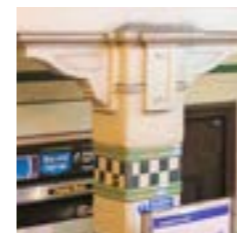

Column and capital  
(Maida Vale)

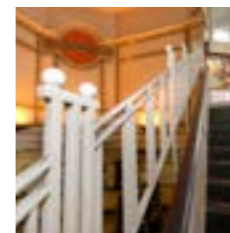

Balustrade  
(Maida Vale)

## Examples stations

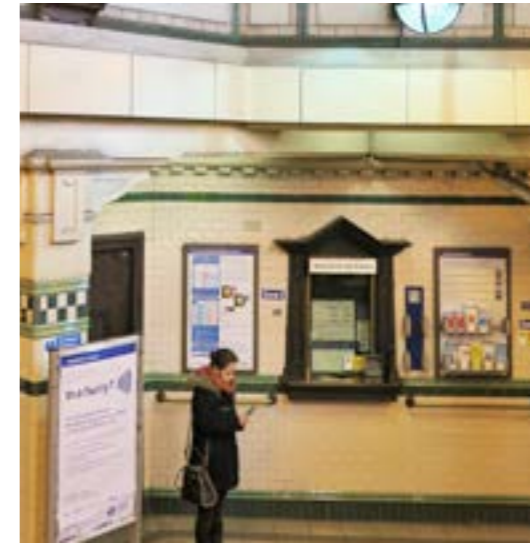

Maida Vale ticket hall



Maida Vale station exterior



Maida Vale routeway



Warwick Avenue platform



**Heaps (Later)** – These are ‘Neo-Grec’ style stations on the 1924 Edgware extension that make much use of classical Portland stone exteriors, ceramic tiling to interiors and ponderous platform canopies.

## Stations

- Brent Cross
- Burnt Oak
- Colindale (platforms)
- Edgware
- Hendon Central

## Colour

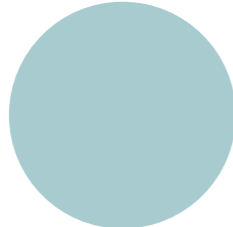

Ribbon blue  
NCS-S 2030-B10G

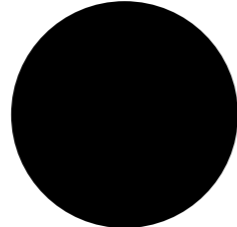

Black  
NCS-S 9000-N

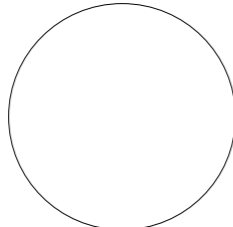

White  
NCS-S 0500-N



Light oak  
Varnished timber



Trim colour  
Bronze finished brushed stainless steel

## Materiality

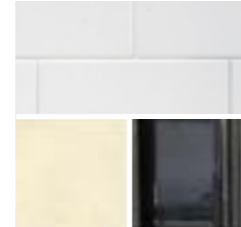

Ceramic  
White/cream  
Wall details/panels

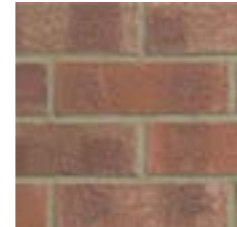

Brick  
Red



Portland stone

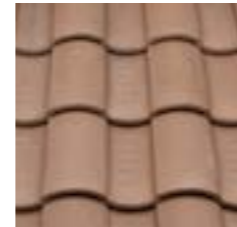

Pantile roof  
Brown

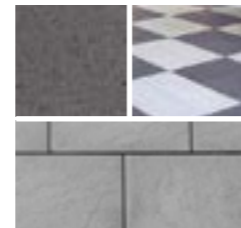

Floor tiles/pavers  
Terrazzo (int/ext)  
Checkerboard (int)  
Concrete flagstones (ext)



Timber  
Painted valance (plat)  
(Colindale)

## Special features



Neo-Georgian columns, bronze balcony hand rails and lettering (Hendon Central)



Platform self-winding clock  
(Colindale)



Platform bench with London Underground 'tomb stone sign' (Colindale and Burnt Oak)



Checkerboard floor (Brent Cross)



Platform canopy detail  
(Colindale)



Decorative timber work  
Door (Brent Cross)



Decorative iron work  
(Brent Cross)

## Examples stations



Hendon Central ticket hall



Hendon Central exterior



Brent Cross exterior



Colindale platform



Brent Cross ticket hall



# 10.11 Holden (Northern style)

**Holden (Northern) Style** – The first foray of Charles Holden, the Underground’s consultant architect, into classically designed stations connected with the Morden extension of 1926. They feature Portland stone exteriors of a similar design, with more traditional tiled interiors.

## Stations

- Balham
- Borough
- Clapham Common
- Clapham North
- Clapham South
- Colliers Wood
- Elephant & Castle (Northern line platforms)
- Kennington
- Morden
- Oval
- South Wimbledon
- St. James’s Park (platforms)
- Tooting Bec
- Tooting Broadway

## Colour

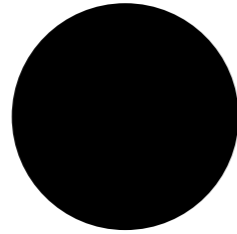

Black  
NCS-S 9000-N

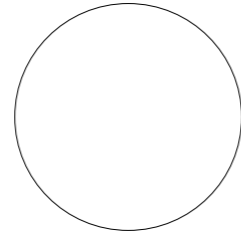

White  
NCS-S 0500-N

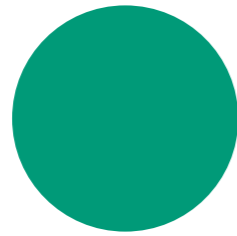

Green  
NCS-S 3050-G

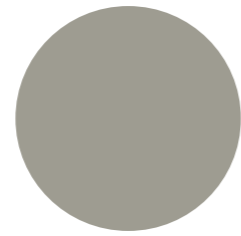

Light grey  
NCS-S 4502-B

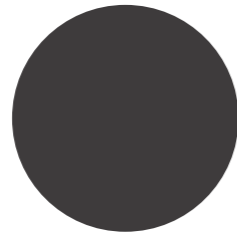

Dark grey  
NCS-S 38500-N



Varnished timber



Trim colour  
Bronze finished brushed stainless steel

## Materiality

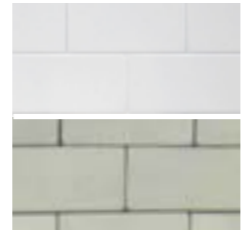

Ceramic/vitreous enamel white



Portland stone



Timber signage



Bronze  
Inset/poster frames



Painted Crittall windows (Balham)



Floor tiles/pavers  
Terrazzo (int)  
Concrete flagstones (ext)



Varnished timber (Clapham South)

## Special features



Original Underground sign and capitals (Balham)



Detail of Portland stone facade (Balham)



Electrolier (Balham)



Platform self winding clock (Tooting Bec)



Ceramic (Clapham South)  
Bottle green/grey/bull nosed blue and black tiled borders, skirting, frieze and advert panels



Wall mounted escalator down light (South Wimbledon)

## Examples stations



Clapham South ticket hall



Balham exterior



Colliers Wood platform



Tooting Bec platform



Clapham South escalator headwalls

# 10.12 Holden (Piccadilly Style)

**Holden (Piccadilly) Style** – Designed by Charles Holden primarily for the 1932/33 Piccadilly line extensions. These stations marked a new era in Underground stations, with groundbreaking use of brick, concrete and spatial layouts.

## Stations

- Acton Town
- Alperton
- Arnos Grove
- Boston Manor
- Bounds Green
- Chiswick Park
- Cockfosters
- Ealing Common
- Eastcote
- Harrow-on-the-Hill
- Hounslow West
- Manor House
- Northfields
- Oakwood
- Osterley
- Park Royal
- Piccadilly Circus (entrances and ticket hall)
- Queensbury
- Rayners Lane
- Ruislip Manor
- Southgate
- South Harrow
- Sudbury Hill
- Sudbury Town
- Turnpike Lane
- Uxbridge
- Wood Green

## Colour

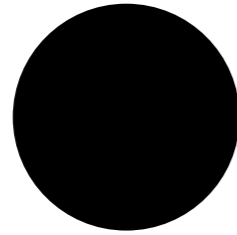

Black  
NCS-S 9000-N

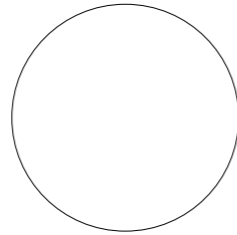

White  
NCS-S 0500-N



Trim colour  
Bronze finished brushed stainless steel

## Materiality



Bronze  
Info board-frames/  
uplighter



Varnished timber  
(Arnos Grove)



Ceramic  
Cream



Brick  
Red / glazed black  
(Oakwood)

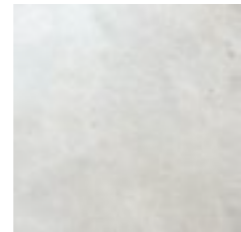

Polished concrete

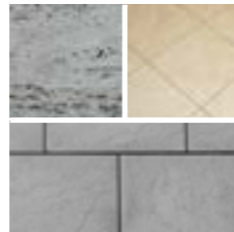

Floor tiles/pavers  
Travertine (int)  
St James style tiles (int)  
Concrete flagstones (ext)



Crittall windows  
(Sudbury Town)

## Special features



Structure expressed interior and white painted ceiling  
(Sudbury Hill)



Orange ceiling soffit colour wash (Alperton)



Bronze uplighter  
(Manor House)



Pendant light  
(Cockfosters)

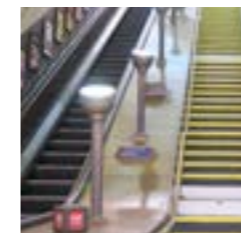

Escalator uplighter  
(Southgate)



Concrete external lamp post  
(Southgate and Rayners Lane platform)

## Examples stations



Sudbury Town exterior



Southgate exterior



Cockfosters train shed interior



Arnos Grove interior



# 10.13 JLE style

**JLE Style** – An important group of stations from the 1999 Jubilee line extension to Stratford. Overseen by architect Roland Paoletti. These stations are among the finest late 20th Century public buildings in the UK.

## Stations

- Bermondsey
- Canada Water
- Canary Wharf
- Canning Town
- London Bridge
- North Greenwich
- Southwark
- Stratford (Jubilee line areas)
- Waterloo (Jubilee line)
- West Ham
- Westminster

## Colour

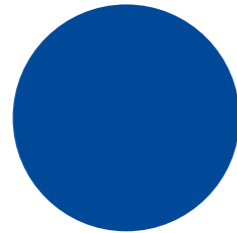

Corporate blue  
NCS-S 4550-R80B

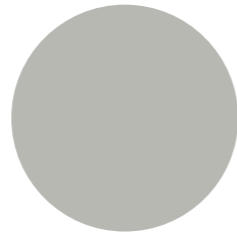

Zinc grey  
NCS-S 3500-N

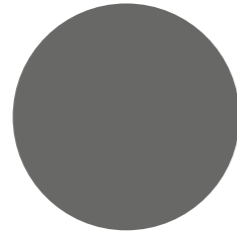

Dark grey  
NCS-S 6502-Y

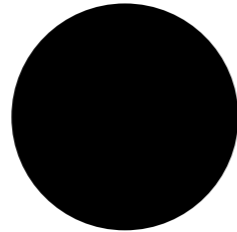

Black  
NCS-S 9000-N

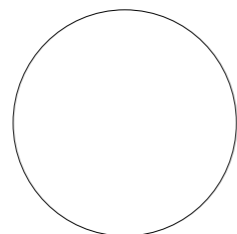

White  
NCS-S 0500-N



Trim colour  
Brushed stainless steel

## Materiality



Tunnel forming rings and stove enamelled plates (Westminster)



Precast and in-situ exposed concrete (Canary Wharf)



Vitreous enamel (London Bridge)



Back painted blue glass (Southwark)



Stainless steel panels (Southwark)



Brick (West Ham)



Structural steel



Floor tiles/pavers  
Terrazzo (int)  
Mid grey concrete pavers (ext)

## Special features



Expressed structure and connections (Westminster)



Backlit glass frieze (Bermondsey)



Concealed architectural lighting (Southwark)



Mosaic tiles  
Blue (North Greenwich)

## Examples stations



Canary Wharf



Westminster



Southwark



Southwark

**Late 1970s** – Only two stations (Hatton Cross and Bond Street), idiomatic of the lull in construction at this time, demonstrate the use of concrete and almost 'Brutalism' architecture of the period.

## Stations

Bond Street (Jubilee line platforms)  
Hatton Cross

## Materiality

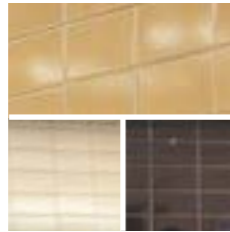

Tiles  
Three shades of light-brown (Hatton Cross)



Pressed metal (plat)  
(Hatton Cross)



Trim colour  
Brushed stainless steel



Textured concrete  
(Hatton Cross)



Floor tiles  
Terrazzo (plat)

## Special features



Mosaic and motif (plat)  
'Imperial airways' motif (Hatton Cross)



Backlit platform roundels (Hatton Cross)



Seat back tiles  
(Bond Street)



Frieze (Bond Street)



Entrance door handle  
(Hatton Cross)

## Examples stations



Bond Street platform (Jubilee line)



Hatton Cross platform



Hatton Cross exterior



Hatton Cross concourse



**Leslie Green** – One of the trademark styles of stations, these opened in 1906/07 and were designed by Leslie Green. They feature oxblood red faience exteriors, ceramic tiled ticket halls and platforms distinguished by colour patterns which are unique to each station.

## Stations

- Aldwych
- Archway (platforms)
- Arsenal
- Baker Street (ticket hall, passageways, intermediate concourses and Bakerloo line platforms)
- Belsize Park
- Caledonian Road
- Camden Town
- Chalk Farm
- Covent Garden
- Earls Court (Piccadilly line platforms and eastern facade)
- Edgware Road (Bakerloo)
- Elephant & Castle (Bakerloo line ticket hall and platforms)
- Gloucester Road (surface buildings and Piccadilly line platforms)
- Golders Green
- Goodge Street
- Hampstead
- Holloway Road
- Hyde Park Corner
- Kentish Town
- Lambeth North
- Marylebone
- Mornington Crescent
- Paddington (Bakerloo line platforms)
- Regent's Park
- Russell Square
- Tufnell Park
- South Kensington (Piccadilly line platforms, lower access passageways and surface buildings)
- Warren Street (Northern line platforms)

## Colour

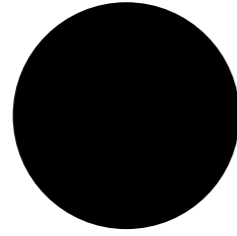

Black  
NCS-S 9000-N

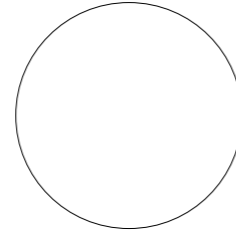

White  
NCS-S 0500-N

Passageways and platforms are 'station specific'



Trim colour  
Bronze finished brushed stainless steel

## Materiality



Glazed oxblood faience terracotta  
Wall details (ext)



Painted plaster



Timber



Ceramic



Floor tiles/pavers  
Terrazzo (int)  
Concrete flagstones (ext)

## Special features



Glazed oxblood faience terracotta facade with arched windows (Camden Town)



Acanthus (Regent's Park) /Pomegranate (Holloway Road)



Platform tile pattern (Tufnell Park)



Painted plaster portal frame (Regent's Park)



Tiled ticket window with wall mounted downlight (Holloway Road)



Tiled details (Covent Garden)



Platform tile pattern (Chalk Farm)



Exterior wall mounted Light (Camden Town)

## Examples stations



Russell Square exterior



Holloway Road ticket hall

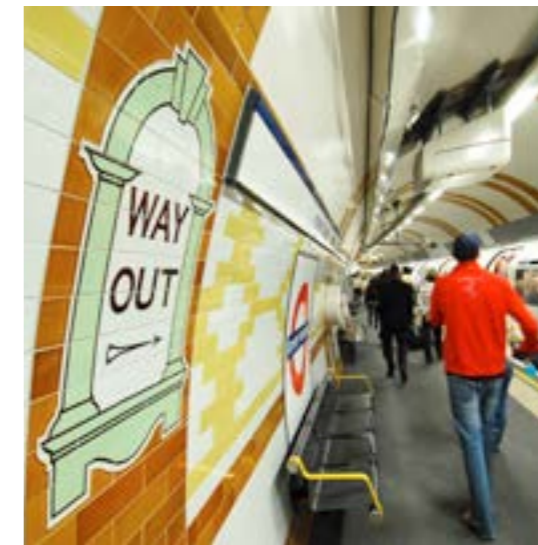

Covent Garden platform



Regent's Park routeway bottle green tiles with frieze



# 10.16 London, Midland and Scottish Railway (Upminster)

**London, Midland and Scottish Railway** – Among the few completely new stations constructed by the mainline London, Midland and Scottish Railway for the 1930's eastern extension of the District line, these stations are almost Art Deco in places, with simple, brick built stations featuring massive steel girder platform canopies. The same style is to be seen on sections of the Bakerloo/Overground north of Queens Park.

## Stations

- Becontree
- Dagenham East
- Dagenham Heathway
- Elm Park
- Hornchurch
- South Kenton
- Upminster Bridge
- Upney

## Colour

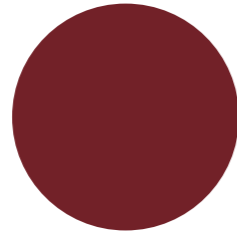

Crimson red  
NCS-3560-Y90R

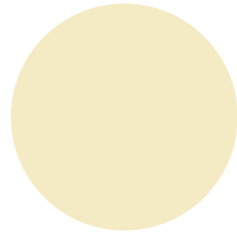

Cream  
NCS-S 0907-G90Y

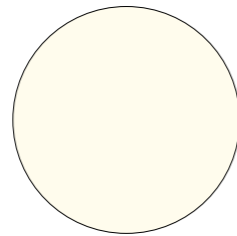

White  
NCS 0502 Y

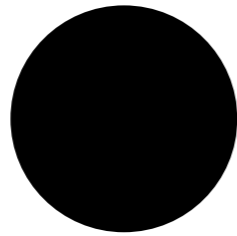

Black  
NCS-S 9000-N



Trim colour  
Brushed stainless steel

## Materiality

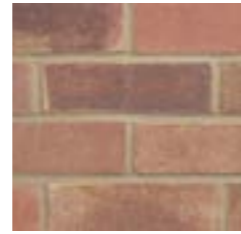

Brick  
Fletton

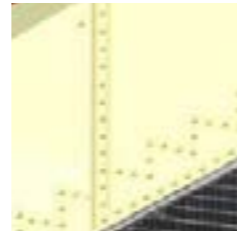

Riveted steel panel



Timber  
Painted sills / window  
frames

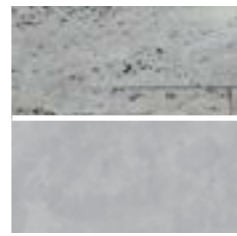

Floor tiles/pavers  
Travertine floor (int)  
Mid grey concrete pavers (ext)



Steel  
Canopy supports (plat)

## Special features



Structural brackets  
(Upminster Bridge)



Riveted steel paneled fully enclosed stairs  
(Dagenham East)



Brick construction  
Flemish bond  
(station specific)



Façade brickwork  
(Upminster Bridge)



Rainwater hopper  
(Hornchurch)



'Sanskrit' granolithic motif  
(Upminster Bridge)

## Examples stations



Upminster Bridge



Dagenham East  
Fletton brick façade with blue canopy



Hornchurch  
Heritage benches with cast iron 'rustic' support frames



Becontree  
Fletton brick with painted timber doors



Elm Park  
Island platform canopy



Upminster Bridge platform



# 10.17 Metropolitan Victorian

**Metropolitan Victorian** – Brick built, often with ornate canopies, these stations typify the extension of the Metropolitan line into open country during the 1880s and 90s.

## Stations

- Aldgate (train shed)
- Amersham
- Baker Street (Hammersmith & City line platforms)
- Chalfont & Latimer
- Chesham
- Chorleywood
- Farringdon (train shed)
- Great Portland Street (platforms)
- Neasden
- Pinner
- Rickmansworth (following 1980s reconstruction)
- Ruislip

## Colour

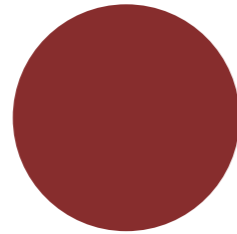

Maroon  
NCS-S5040R

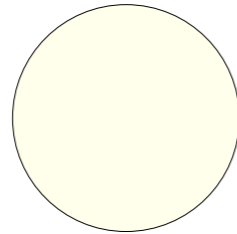

Light cream  
NCS S0605-Y26R

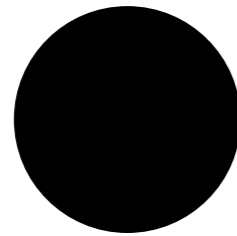

Black  
NCS-S 9000-N



Trim colour  
Bronze finished brushed stainless steel

## Materiality



Ceramic  
White



Brick  
Red/yellow/London stock

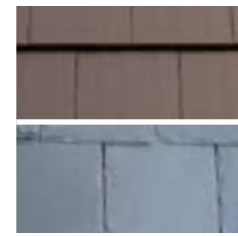

Slate  
Roof tiles

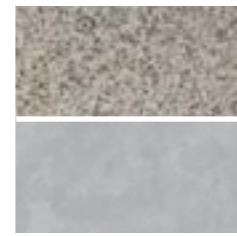

Floor tiles/pavers  
Grey granite (int)  
Concrete slabs (ext)



Cast iron  
Canopy supports (plat)



Timber  
Painted panels

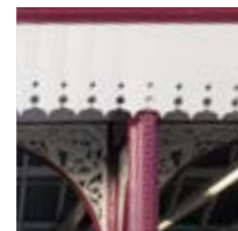

Timber  
Painted valance (plat)

## Special features



Decorative brackets (Chesham)



Lattice Bridge (Amersham)



Ridge and furrow canopy (Amersham)



Brick construction  
Flemish bond  
(Chalfont & Latimer)

## Examples stations



Ruislip exterior



Chesham exterior



Chalfont & Latimer platform



Farringdon (train shed)



Chalfont & Latimer exterior



# 10.18 New Works (pre WWII and post WWII)

**New Works Programme** – These stations formed part of the extension and reconstruction of the London Passenger Transport Board (LPTB) ‘New Works Programme’, an investment programme in 1935 - 40s that was delayed by the Second World War. The station designs are ‘guided’ by Holden but often used other architects.

## Stations

### Pre WWII

- Aldgate East
- Chancery Lane (entrances)
- Dollis Hill
- East Finchley
- Finchley Road
- Kilburn
- Leicester Square (ticket hall and entrances)
- Loughton
- Highgate
- High Street Kensington (ticket hall)
- St. John’s Wood
- Swiss Cottage
- West Hampstead

### Post WWII

- Bethnal Green
- Earl’s Court (western entrance)
- Gants Hill
- Greenford
- Hainault (excluding platform 1)
- Hanger Lane
- Leytonstone
- Mile End
- Moor Park
- Newbury Park (except platforms)
- Privale
- Redbridge
- Wanstead
- West Acton
- White City

## Colour

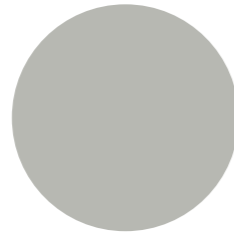

Zinc grey  
NCS-S 3500-N

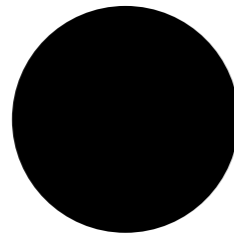

Black  
NCS-S 9000-N

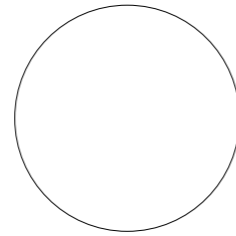

White  
NCS-S 0500-N



Trim colour  
Bronze finished brushed stainless steel

## Materiality



Brick



Concrete



Ceramic  
Cream  
Wall details (int)



Faience block  
Cream



Bronze



Steel  
Crittall windows  
(White City)

## Special features



Station benches  
(White City)



Bronze handrails  
(Bethnal Green)



Platform frieze  
(Bethnal Green)



Clock (Bethnal Green)



Stabler tile  
(Bethnal Green)



Stabler tile  
(Bethnal Green)



Platform frieze  
(Wanstead)

## Examples stations



Redbridge exterior



White City



Bethnal Green subway entrance



Bethnal Green



# 10.19 Victoria line style

**Victoria line style** – Designed by the Design Research Unit for LT’s two-stage opening of the Victoria line in 1969–71. Only Blackhorse Road has a surface presence. Below ground spaces denoted by the use of grey shade 6ins x 6ins ceramic tiles with stainless steel trims, only enlightened by the unique designs of tiles to the seat alcoves at platform levels.

## Stations

- Blackhorse Road
- Brixton
- Euston (Victoria line platforms)
- Finsbury Park (Victoria line platforms)
- Green Park (Victoria line platforms)
- Highbury & Islington
- Kings Cross St. Pancras (Victoria line platforms)
- Oxford Circus (Victoria line platforms)
- Pimlico
- Seven Sisters
- Stockwell
- Tottenham Hale
- Vauxhall
- Victoria (Victoria line platforms)
- Walthamstow Cental
- Warren Street (ticket hall, routeways and Victoria line platforms)

## Colour

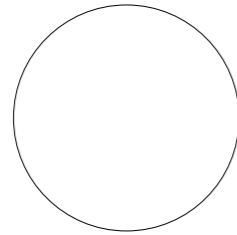

White  
NCS-S 0500-N

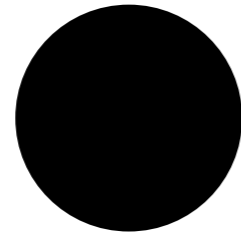

Black  
NCS-S 9000-N

Various 'station specific' shades



Trim colour  
Brushed stainless steel

## Materiality



Ceramic



Brick  
Dark grey



Natural aluminum



Brushed stainless steel



Floor tiles/pavers  
Terrazzo (int)  
Travertine floor (int)



Floor tiles/pavers  
Concrete flagstones (ext)

## Special features



Glass backlit platform roundel (Pimlico)



Tunnel head and tail clock (Blackhorse Road)



Platform tube light (Vauxhall)



Platform tube light and lighthood (Blackhorse Road)



Seat back tiles (Seven Sisters)



Seat back tiles (Finsbury Park)

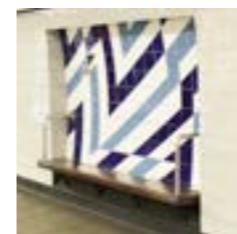

Seat back tiles (Stockwell)



Seat back tiles (Blackhorse Road)

## Examples stations



Vauxhall platform



Euston platform



Blackhorse road platform



Pimlico platform



# 10.20 Whitechapel and Bow, LTSR and LNWR

**Whitechapel and Bow, London, Tilbury & Southend Railway (LTSR) and London and North Western Railway (LNWR)** – These are brick built stations from the 1902 sub-surface extensions east of Whitechapel and the surface stations of the LTSR. This style also includes station on the LNWR Euston-Watford electrification opened during WWI.

## Stations

### North-West

- Harlesden
- Harrow & Wealdstone
- Kensal Green
- Kenton
- North Wembley
- Queen's Park (train shed only)
- Stonebridge Park
- Willesden Junction (partial)

### East

- Bow Road
- East Ham
- Plaistow
- Stepney Green
- Upton Park

## Colour

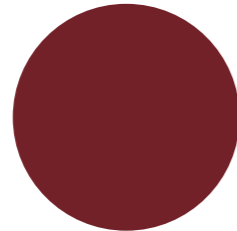

Crimson red  
NCS-3560-Y90R



Cream  
NCS-S 0907-G90Y

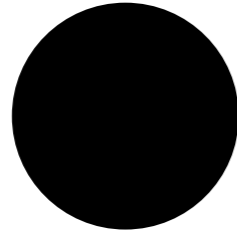

Black  
NCS-S 9000-N

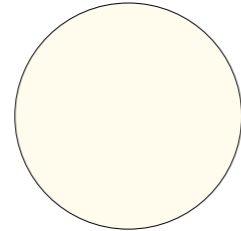

White  
NCS 0502 Y



Trim colour  
Bronze finished brushed stainless steel

## Materiality

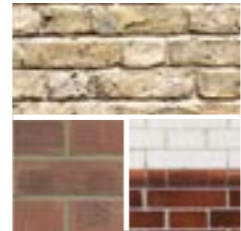

Brick  
London stock/red/glazed (East Ham ticket hall and routeway staircases)



Timber  
Painted window frames



Cast iron  
Canopy supports (plat)



Timber  
Painted valance (plat)

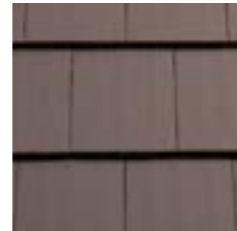

Slate tiles  
Roof tiles



Floor tiles/pavers  
Grey granite  
Concrete slabs



Cast iron  
Canopy supports (plat)

## Special features



Decorative brackets (Plaistow)



Roof ironwork (Plaistow)



Column (Plaistow)



LTSR benches (Plaistow)

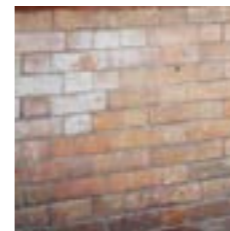

Brick construction  
Flemish bond  
(station specific)

## Examples stations



Plaistow  
Red brick façade with stock brick window and door surrounds



Plaistow ticket hall  
Painted ironwork, glazing bars and timber plank soffit



Bow Road platforms  
Painted ironwork and timber canopy



Harrow & Wealdstone platform  
(Bakerloo line side)



**2015 Palette** – Stations that do not preserve any major elements of the above design types and that would be reconstructed, redeveloped or modernised using the 2015 LU Design Idiom.

## Stations

- |  |   |
|--|---|
| Angel  | Knightsbridge                                       |
| Archway (excluding platforms)                                | Leicester Square (platforms)                        |
| Bank   | Liverpool Street (excluding Central line platforms) |
| Barbican   | Mansion House                                       |
| Battersea  | Monument  |
| Blackfriars  | Moorgate  |
| Bromley-by-Bow   | Nine Elms   |
| Cannon Street  | Northolt  |
| Charing Cross  | Northwood   |
| Colindale (excluding platforms)                              | Old Street  |
| Debden   | Paddington (Hammersmith and City)                   |
| Elephant & Castle (Northern ticket hall)                     | Piccadilly Circus (platforms)                       |
| Embankment   | Roding Valley                                       |
| Euston (excluding Victoria line platforms)                   | Ruislip Gardens                                     |
| Euston Square  | Sloane Square                                       |
| Finsbury Park  | Shepherd's Bush (ticket hall)                       |
| Fulham Broadway (excluding train shed)                       | South Ealing  |
| Green Park   | South Ruislip                                       |
| Gunnersbury  | Stratford (excluding Jubilee line areas)            |
| Hammersmith (District and Piccadilly lines)                  | Tower Hill  |
| Heathrow Terminals 1,2,3                                     | Victoria (excluding Victoria line platforms)        |
| Heathrow Terminals 4   | Waterloo (excluding Jubilee line areas)             |
| Heathrow Terminals 5   | Wembley Central                                     |
| Hillingdon   | Wembley Park  |
| Holborn  | West Harrow   |
| Hounslow East  | West Ruislip  |
| Ickenham   | Whitechapel   |
| King's Cross St. Pancras (excluding Victoria line platforms) | Wood Lane   |

## Colour

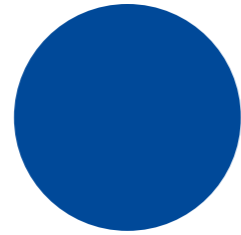

Corporate blue  
NCS-S 4550-R80B

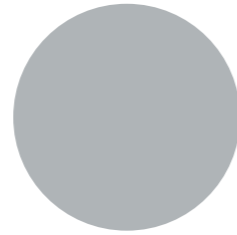

Corporate light grey  
NCS-S 4005-R80B

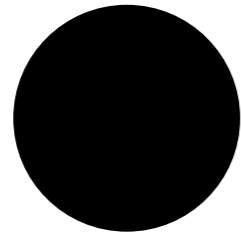

Black  
NCS-S 9000-N

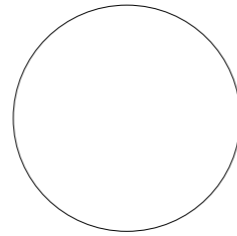

White  
NCS-S 0500-N



Trim colour  
Bronze finished brushed stainless steel

## Materiality

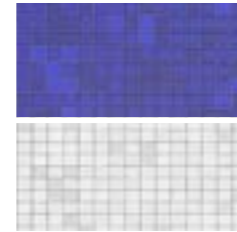

Mosaic  
Blue/white



Glazed ceramic  
Blue/white

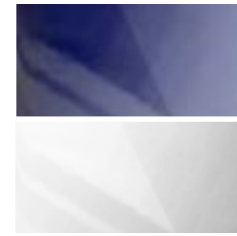

Back painted glass  
Blue/white



Corrugated and coated stainless  
Blue/bronze



Coated stainless  
Blue/bronze



Travertine stone



Concrete  
In situ/precast/  
precast textured

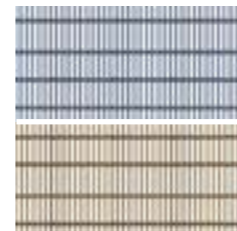

Stainless steel woven mesh  
Blue/bronze

## Special features



Textured cast concrete



Cast concrete



Stainless steel woven mesh ceiling



Varied glaze weight ceramic

## Examples stations



Routeways



Escalator routeways



Platform



Ticket hall

# 11.0

## References





# 11.0 References

**This section provides details of relevant documents which can give you more information about carrying out work in stations and how to apply the principles of the Design Idiom.**

## **Strategy & Service Development standards and guidance documents**

The S&SD standards are currently under review and new versions will be issued in due course. This may mean some changes to the titles and reference numbers set out below.

I-311 Station signing for customers  
 I-312 Automated audio and visual information in public areas of stations and trains  
 I-313 Poster frames, leaflet racks and whiteboards in stations  
 I-332 Provision and use of emergency help facilities  
 I-351 Station decor design  
 I-352 Station ambience  
 I-355 Listed buildings and other structures of design or historical importance  
 I-358 Sightlines, visual clutter and visual space planning  
 I-357 Heritage signing handbook  
 I-361 Station amenities and facilities  
 S1365 New retail units provided through major stations  
 S1371 Station planning  
 Good Practice Guide – Amenities and facilities  
 Good Practice Guide – Customer information  
 Good Practice Guide – Managing Underground heritage  
 Good Practice Guide – Station Presentation Handbook  
 Customer Information Hierarchy

## **London Underground Engineering standards and guidance documents**

Some engineering standards are being updated to reflect the requirements of the Design Idiom and new versions will be issued in due course; the references below are to the existing standards.

SI131 A5 Premises – Station Platforms  
 SI132 A5 Premises – Barriers and Fencing (Non-Lineside)  
 SI133 A9 Premises – Stairways and Ramps  
 SI134 A3 Premises – Doorsets and Glazing  
 SI135 A4 Premises – Finishes  
 G0131B A2 Guidance on Station Platforms  
 G0132 A3 Guidance on Barriers and Fencing  
 G0133 A1 Guidance on Stairways and Ramps  
 G0134A A2 Guidance on Glazing  
 G0134B A2 Guidance on Doorsets and Gates  
 G0135 A2 Guidance on Premises Finishes  
  
 S1053 A12 Civil Engineering – Building and Station Structures  
 I-065 A1 Platform Edge Doors  
 I-066 A3 Lighting of London Underground Assets  
 I-085 A3 Fire Safety Performance of Materials  
 S1093 A3 PMVT Lifts  
 S1094 A3 Heavy Duty Metro Type Escalators and Moving Walks  
 S1095 SMVT Lifts  
 SI147 A1 Surveillance and Security Systems  
 I-142 A4 Operational Information Systems



## TfL guidance documents

Retail design guide 2015  
TfL Station public realm design guidance 2015  
TfL Advertising and service information standard  
Streetscape guidance: A guide to better streets 2009. An updated version of this document will be available in 2015  
TfL Interchange best practice guidelines 2009  
London Underground Signs Manual  
TfL Door signs in the customer environment  
TfL Standard for TfL products

## National standards and guidance documents

There are a number of national documents which provide guidance for building work. These should be followed except where their requirements are exceeded by the requirements of the LU standards.

BS8300: Design of buildings and their approaches to meet the needs of disabled people (2009)  
Building regulations part M - access to and use of buildings (2013)

## Photography

With thanks to the London Transport Museum for their permission to use photographs from their collection throughout this document.



# Index

**2015 palette**, 114, 118, 119, 120, 121, 219

**Accessibility**, 21, 22, 23, 24, 26, 27, 73, 74

**Advertising**, 21, 25, 71, 80, 105, 150, 168, 169, 174, 175, 176, 177, 178, 180, 181, 192

**Ambience**, 15, 45, 104, 137

**Art**, 11, 71, 99, 104

**Back of house**, 79, 80, 91

**Balance**, 17, 32, 34, 36, 42, 43, 45, 47, 48, 49, 178, 193

**Benches**, 168, 178

**Bins**, 168

**Bostwick gates**, 51, 66

**Cable Management System (CMS)**, 79, 92, 158

**Camden Town**, 48

**Case studies**, 48, 65, 134, 181, 194

**Cash machines**, 47, 168

**CCTV**, 168, 172

**Ceilings**, 116, 129, 159

**Ceilings – finishes**, 116

**Central London Railway**, 200

**Clarke (City style)**, 201

**Clarke (suburban style)**, 202

**Clutter**, 18, 19, 75, 76, 78, 79, 80, 84, 151

**Columns**, 130, 159, 188

**Commerce**, 19, 23, 41, 60, 81, 168

**Crime and Disorder Act**, 78

**Culture**, 19, 104

**Customer experience**, 12, 15, 16

**Customer information** , 23, 26, 27, 43, 47, 80, 174, 175, 178, 181

**Customer information zone**, 167, 168, 175

**Declutter**, 11, 13, 76, 77

**Delight**, 97

**Design legacy**, 15, 104

**Design parameters**, ?

**Design principles**, 9, 29

**Destination station**, 55, 171

**District Victorian**, 203

**Escalators**, 21, 25, 117, 120, 145, 150, 159, 169, 176, 192

**ESUB**, 174, 175

**Existing station**, 132, 134

**Façades**, 123

**Faience**, 110, 123, 124

**Fixing**, 124, 130, 133

**Flashcards**, 113, 198

**Floors**, 116, 124, 128

**Floors - finishes**, ?

**Frieze**, 127, 130, 151

**Frontage**, 61, 63

**Gateline**, 23, 148

**Gateway station**, 55, 171

**Great Eastern**, 204

**Great Northern**, 205

**Great Western**, 206

**Green wall**, 61, 101

**Halo**, 167

**Handrails**, 124, 130, 131

**Heaps (early)**, 207

**Heaps (later)**, 208

**Help point**, 40, 168, 174, 175, 178

**Heritage**, 19, 32, 44, 71, 99, 100, 159, 199

**Hierarchy**, 12, 47, 170

**Holden (Northern line style)**, 209

**Holden (Piccadilly line style)**, 210

**Ideal station**, 21

**Illuminance criteria** 158

**Individuality** 104, 106, 140

**JLE style**, 211

**Jointing**, 127

**Kings Cross St Pancras**, 181

**Kiosks**, 168

**Late 1970s**, 212

**Legible spaces**, 75

**Leslie Green**, 123, 207, 213

**Lifts**, 73, 120, 176

**Light - layers of Lighting**, 143

**Lighting – escalators and stairs**, 150, 154

**Lighting – feature**, 155, 156, 159

**Lighting – orientation**, 21, 25, 26, 139, 142, 146, 148, 149, 150, 151, 155, 161

**Lighting - performance**, 160, 162

**Lighting – platforms**, 26, 27, 151, 155

**Lighting – routeways,** 149, 159

**Lighting – station exterior,** 22, 146

**Lighting – ticket halls,** 148

**Lighting –accent,** 141, 146, 148, 149, 150, 151, 154, 155

**Lighting principles** 140, 163

**Listed buildings,** 44

**Local history,** 59

**Local information,** 167, 172

**Local station,** 55

**London Midland & Scottish Railway,** 214

**Luminaire aesthetics,** 156

**Luminaires,** 143, 151, 156, 157, 158, 159, 160, 162

**Maintenance,** 71, 140, 187, 190, 191

**Materials,** 23, 24, 25, 108, 117, 127, 134, 186, 188, 193

**Materials formats,** 127

**Mesh,** 123, 124

**Metro station,** 55, 140

**Metropolitan Victorian,** 215

**Modular systems,** 126, 188, 191

**Natural light,** 22, 23, 101

**Nature,** 101

**Network,** 9, 32, 36, 38, 39, 112, 140, 167

**New stations,** 63, 84, 131

**New works (pre-WWII and post-WWII),** 132, 216

**Night Tube,** 161, 171

**North Western Railway,** 218

**Ownership,** 89

**Oxford Circus,** 194

**Paint,** 116

**Panelling,** 111

**Platforms,** 178

**POMs - see ticket machines,** 158, 171

**Poster frame,** 122, 165, 170, 175

**Products,** 165, 167, 169, 182, 186

**Retail,** 22, 41, 43, 47, 60, 71, 168, 192

**Retail design guide,** 81

**Roundel,** 22, 178, 179

**Roundel, history of,** 36

**Routeways,** 21, 24, 117, 119, 149, 169, 171, 177

**Safety,** 168, 178

**Safety equipment cabinet,** 168

**Seats,** 168

**Security,** 18, 22, 168

**Setting out,** 127

**Signage,** 158, 167, 168, 178

**Skirting,** 116, 128

**Southgate,** 65

**Staff, role of Staff door,** 90, 91

**Staff seat,** 168, 171

**Stairs,** 116, 120, 130, 131, 150, 159, 176

**Station canopy,** 173

**Station design types,** 112

**Station exteriors,** 122, 146, 170

**Step-free access,** 73

**Tactiles,** 114, 116

**Technology, emerging,** 192

**Technology, lighting,** 160, 162

**Ticket hall,** 21, 23, 90, 117, 118, 145, 148, 169, 171, 174

**Ticket machine(s),** 91, 167

**Tiles,** 59, 111, 124

**Totem,** 167, 173

**Tube map,** 37, 171

**Victoria line style,** 217

**Vision,** 19, 30

**Visual perception,** 143

**Walls,** 115, 130

**Walls - finishes,** 115

**Whitechapel and Bow, LTSR & LNWR,** 218

**Whole life, designing for,** 186

**Life cycle costs,** 187





London Underground

**Station Design Idiom**

